

2022 HANKOOK TIRE
**TRUCK & BUS
TIRE CATALOG**

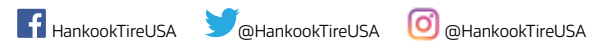

Hankook Tire America Headquarters
333 Commerce Street, Suite 600 Nashville, Tennessee 37201, USA T +1 615 432 0700 F +1 615 242 8709
www.hankooktire.com



hankooktire.com



™/© 2022 MLB

TBR

Truck and Bus Radial Tire

Hankook TBR Product Overview	3
Hankook Tire Range	5

Long Haul

AL21	7
DL21	7
DL15(+)	8
DL12	8
DL11	9
TL21	9
AL22	10

Regional Haul

AH24	11
AH37	11
DH06	12
DH37	12
TH31	13

Pickup & Delivery

AH35	14
DH35	14
DH07	15
AU04	15

Mixed Service

AM15(+)	16
AH32	16
DM09	17
DM04	17
AM09(+)	18

Ultra Super Single

e ³ WiDE DL21	19
e ³ WiDE DL12	19
e ³ WiDE TL21	20

Product Positioning Map	23
Comparison Chart	24
Tire Reference Chart	25
Basic Tire Knowledge	27
Important Safety Warning	29
Limited Warranty	41
Claim Adjustment Procedure	43
Claim Form Sample	45
Freight Policy/General Terms & Policies	47
Credit Percentage Table	49
Load Inflation Pressure Tables	51

NOTES

- T/L : Tubeless Type
- M+S : Mud & Snow
- UMS : Ultra Mileage & Safety
- 3PMSF : Three Peak Mountain Snowflake

This List cancels all previous lists and is subject to change without prior notice



2022 HANKOOK TIRE TBR PRODUCT OVERVIEW



	Long Haul	Regional	Pickup & Delivery	On&Off
General Commercial Vehicle				
Special Purpose				
Winter				

- Smart Line: Optimized for fuel efficiency and high speed for long distance driving.
- Smart Flex: Optimized for long tread life and durability at all types of driving in all-weather.
- Smart Work: Optimized for toughness, traction with high load on aggressive road surface.

- Smart City: Optimized for even wear and smooth traction during frequent stop & go driving.
- Smart Touring: Optimized for a comfortable and safe journey while driving passengers.
- Smart Control: Optimized for traction and safety in winter driving.

HANKOOK TIRE RANGE



Optimized for fuel efficiency, endurance at long distance driving. Smart Line offers the best performance in line haul applications.

STEER	e ³ MAX AL21			
DRIVE	e ³ MAX DL21	DL11	Smart Flex DL12	Smart Flex DL15(+)
TRAILER	e ³ MAX TL21			



Optimized for a comfortable and safe journey while driving passengers. Smart Touring offers the best performance in bus application.

STEER	Smart Touring AL22
--------------	--------------------



Optimized for even wear and smooth traction in frequent stop & go driving. Smart City offers the best performance in pickup and delivery driving.

STEER	Smart City AU04(+)
--------------	--------------------



Optimized for long tread life and toughness at all types of driving. Smart Flex offers the best performance in regional applications.

STEER	Smart Flex AH35	AH32	AH37
	AH24		
DRIVE	Smart Flex DH35	DH07	
	DH37	DH06	
TRAILER	Smart Flex TH31		



Optimized for toughness, traction on aggressive road surface. Smart Work offers the best performance in On/Off applications.

STEER	Smart Work AM15(+)	Smart Work AM09
DRIVE	Smart Work DM09	DM04

e³ MAX AL21



Long-Haul "Smartec" Series/Steer Position **Approved for SmartWay & CARB**

e³ MAX AL21 has a stabilized footprint which provides longer mileage by decreasing uneven wear. Optimized lateral siping provides better traction and a round-edge sipe that prevents tearing and cracking. (Unlimited Retreads / 7 years)



Sizes & Specifications (Pattern Code: AL21)

S-Code	Size	Ply Rating	Type	Measuring Rim	Max. Air (PSI)		Max. Load (LBS)		Overall Diameter	Section Width	Tread Width	Tread Depth	Revs/ Mile	SLR (Inch)	Max Speed	Weight (lbs)
					S	D	S	D								
3003108	11R22.5	14	T/L	8.25	105	105	6,175	5,840	41.4	11.1	8.1	19	500	19.3	75	125
3003109	11R22.5	16	T/L	8.25	120	120	6,610	6,005	41.4	11.1	8.1	19	498	19.4	75	125
3003110	11R24.5	14	T/L	8.25	105	105	6,610	6,005	43.5	11.3	8.1	19	477	20.3	75	131
3002431	295/75R22.5	14	T/L	8.25	110	110	6,175	5,675	40.2	11.7	8.5	19	514	18.7	75	114
3002488	295/75R22.5	16	T/L	8.25	120	120	7,160	6,610	40.2	11.7	8.5	19	514	18.6	75	114
3003112	285/75R24.5	14	T/L	8.25	110	110	6,175	5,675	41.5	10.9	8.1	19	499	19.4	75	124

• Use inflation pressure specifications on vehicle tire placard.
• Tire construction and material specifications subject to change without notice or obligation.

OE Manufacturer Partner



Recommended Vehicle Types & Position



e³ MAX DL21



Premium Long Haul / Drive Position **Approved for SmartWay & CARB**

Engineered to maximize traction and tread life, the DL21 uses our heel and toe stopper technology to strengthen the tread blocks over time. Its three-dimensional siping design reinforces interlocking between tread blocks to ensure that the tire performs up to its highest ability while also staying reliable. (Unlimited Retreads / 7 years)



Sizes & Specifications (Pattern Code: DL21)

S-Code	Size	Ply Rating	Type	Measuring Rim	Max. Air (PSI)		Max. Load (LBS)		Overall Diameter	Section Width	Tread Width	Tread Depth	Revs/ Mile	SLR (Inch)	Max Speed	Weight (lbs)
					S	D	S	D								
3003179	11R22.5	14	T/L	8.25	105	105	6,175	5,840	42.2	11.3	9.1	30	494	19.7	75	140
3003180	11R22.5	16	T/L	8.25	120	120	6,610	6,005	42.2	11.3	9.1	30	493	19.7	75	140
3003181	11R24.5	14	T/L	8.25	105	105	6,610	6,005	44.3	11.3	9.1	30	472	20.6	75	146
3003182	11R24.5	16	T/L	8.25	120	120	7,160	6,610	44.3	11.3	9.1	30	469	20.6	75	146
3002432	295/75R22.5	14	T/L	8.25	110	110	6,175	5,675	40.7	11.7	9.3	30	510	19.0	75	130
3003183	285/75R24.5	14	T/L	8.25	110	110	6,175	5,675	42.2	11.0	9.3	30	492	19.8	75	138

• Use inflation pressure specifications on vehicle tire placard.
• Tire construction and material specifications subject to change without notice or obligation.

Recommended Vehicle Types & Position



SMART FLEX DL15 (+)



Long & Regional Haul / Drive Position

Utilizing Hankook's three-dimensional deep cut siping and Smartec Technology, the DL15 is designed to maximize fuel efficiency and traction performance for long and regional haul applications. Its tread design is sure to deliver a long lasting and reliable experience.



Sizes & Specifications (Pattern Code: DL15)

S-Code	Size	Ply Rating	Type	Measuring Rim	Max. Air (PSI)		Max. Load (LBS)		Overall Diameter	Section Width	Tread Width	Tread Depth	Revs/ Mile	SLR (Inch)	Max Speed	Weight (lbs)
					S	D	S	D								
* 3003141	11R22.5	14	T/L	8.25	105	105	6,175	5,840	41.8	11.3	9.6	26	501	19.5	75	132
* 3003142	11R22.5	16	T/L	8.25	120	120	6,610	6,005	41.8	11.3	9.6	26	499	19.6	75	132
* 3003143	11R24.5	14	T/L	8.25	105	105	6,610	6,005	44.0	11.3	9.6	26	479	20.5	75	141
* 3003144	11R24.5	16	T/L	8.25	120	120	7,160	6,610	44.0	11.3	9.6	26	477	20.5	75	141
* 3002908	295/75R22.5	14	T/L	8.25	110	110	6,175	5,675	40.7	11.9	9.6	26	515	19.0	75	126
* 3003145	285/75R24.5	14	T/L	8.25	110	110	6,175	5,675	41.9	11.0	9.6	26	499	19.7	75	132

Sizes & Specifications (Pattern Code: DL15+)

S-Code	Size	Ply Rating	Type	Measuring Rim	Max. Air (PSI)		Max. Load (LBS)		Overall Diameter	Section Width	Tread Width	Tread Depth	Revs/ Mile	SLR (Inch)	Max Speed	Weight (lbs)
					S	D	S	D								
New ** 3003870	295/75R22.5	14	T/L	8.25	110	110	6,175	5,675	40.6	11.6	9.6	25	513	19.0	75	124

• Use inflation pressure specifications on vehicle tire placard. • Tire construction and material specifications subject to change without notice or obligation.
* DL15 is discontinued Q2 2022 ** DL15(+)new in Q2 2022

Recommended Vehicle Types & Position



SMART FLEX DL12



Long & Regional Haul / Drive Position

The DL12 incorporates 3D siping, providing excellent traction and long original tread life. Wide tread design and combined structure of rib and block pattern provides stability, longer mileage, and better handling performance in all weather conditions.



Sizes & Specifications (Pattern Code: DL12)

S-Code	Size	Ply Rating	Type	Measuring Rim	Max. Air (PSI)		Max. Load (LBS)		Overall Diameter	Section Width	Tread Width	Tread Depth	Revs/ Mile	SLR (Inch)	Max Speed	Weight (lbs)
					S	D	S	D								
3002142	11R22.5	14	T/L	8.25	105	105	6,175	5,840	42.0	11.3	9.6	28	498	19.6	75	134
3002143	11R22.5	16	T/L	8.25	120	120	6,610	6,005	42.0	11.3	9.6	28	496	19.7	75	134
3002144	11R24.5	14	T/L	8.25	105	105	6,610	6,005	44.0	11.3	9.6	28	475	20.6	75	144
3002145	11R24.5	16	T/L	8.25	120	120	7,160	6,610	44.0	11.3	9.6	28	474	20.6	75	144
3001874	295/75R22.5	14	T/L	8.25	110	110	6,175	5,675	40.7	11.6	9.6	28	511	19.0	75	129
3002140	285/75R24.5	14	T/L	8.25	110	110	6,175	5,675	42.0	11.3	9.6	28	495	19.7	75	137

• Use inflation pressure specifications on vehicle tire placard.
• Tire construction and material specifications subject to change without notice or obligation.

Recommended Vehicle Types & Position



DL11



Long Haul / Drive Position

Approved for SmartWay & CARB

Large blocks with 3D-siping ensure traction capabilities in all weather conditions and improves overall mileage. New tread compound enhances dispersion and fuel efficiency. (Unlimited Retreads / 7 years)

Sizes & Specifications (Pattern Code: DL11)

S-Code	Size	Ply Rating	Type	Measuring Rim	Max. Air (PSI)		Max. Load (LBS)		Overall Diameter	Section Width	Tread Width	Tread Depth	Revs/ Mile	SLR (Inch)	Max Speed	Weight (lbs)
					S	D	S	D								
3001706	11R22.5	14	T/L	8.25	105	105	6,175	5,840	41.9	11.1	8.5	26	498	19.5	75	128
3001705	11R22.5	16	T/L	8.25	120	120	6,610	6,005	41.9	11.1	8.5	26	496	19.6	75	128
3001708	11R24.5	14	T/L	8.25	105	105	6,610	6,005	43.9	11.1	8.5	26	475	20.5	75	135
3001707	11R24.5	16	T/L	8.25	120	120	7,160	6,610	43.9	11.1	8.5	26	474	20.5	75	136
3001592	295/75R22.5	14	T/L	8.25	110	110	6,175	5,675	40.7	11.6	8.5	26	510	19.0	75	121
3001704	285/75R24.5	14	T/L	8.25	110	110	6,175	5,675	41.9	11.3	8.5	26	494	19.4	75	128

• Use inflation pressure specifications on vehicle tire placard. • Tire construction and material specifications subject to change without notice or obligation.

Recommended Vehicle Types & Position



OE Manufacturer Partner



SmartTouring AL22



Highway Coach / All Position

The AL22 delivers excellent braking performance while providing a comfortable and quiet ride. Its three-dimensional siping technology gives the tire excellent braking ability, and the tread design contains a main center rib for longer mileage.



Sizes & Specifications (Pattern Code: AL22)

S-Code	Size	Ply Rating	Type	Measuring Rim	Max. Air (PSI)		Max. Load (LBS)		Overall Diameter	Section Width	Tread Width	Tread Depth	Revs/ Mile	SLR (Inch)	Max Speed	Weight (lbs)
					S	D	S	D								
3003129	315/80R22.5	20	T/L	9.00	130	130	9,090	8,270	42.4	12.4	9.5	18	487	19.6	75	143

• Use inflation pressure specifications on vehicle tire placard. • Tire construction and material specifications subject to change without notice or obligation.

Recommended Vehicle Types & Position

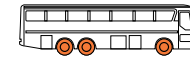

e³MAXTL21

Long Haul / Trailer Position

Approved for SmartWay & CARB

The TL21 contains a formulated tread compound designed to run longer while keeping a lower temperature, ultimately resulting in excellent tread wear. Its tapered grooves also allow for improved fuel efficiency.



Sizes & Specifications (Pattern Code: TL21)

S-Code	Size	Ply Rating	Type	Measuring Rim	Max. Air (PSI)		Max. Load (LBS)		Overall Diameter	Section Width	Tread Width	Tread Depth	Revs/ Mile	SLR (Inch)	Max Speed	Weight (lbs)
					S	D	S	D								
3002769	11R22.5	14	T/L	8.25	105	105	6,175	5,840	41.1	11.0	8.0	12	504	19.1	75	106
3002828	11R24.5	14	T/L	8.25	105	105	6,610	6,005	43.1	11.1	8.0	12	480	20.0	75	112
3002383	295/75R22.5	14	T/L	8.25	110	110	6,175	5,675	39.7	11.6	8.3	12	518	18.5	75	102
3002849	285/75R24.5	14	T/L	8.25	110	110	6,175	5,675	41.1	10.8	8.3	12	504	19.2	75	108

• Use inflation pressure specifications on vehicle tire placard. • Tire construction and material specifications subject to change without notice or obligation.

Recommended Vehicle Types & Position

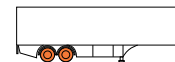

AH24



Premium Regional Haul / All Position

Approved for SmartWay & CARB

Superior performance for local and regional applications focused on resistance to high scrub situations where endurance, durability, and high mileage are vital to intense driving conditions. Solid wide ribs provide gratifying ride control while the improved siping design displaces water for outstanding road grip in adverse weather conditions. An enhanced sidewall fights against damaging abrasions and cuts to extend casing durability and tire life cycle performance.



Sizes & Specifications (Pattern Code: AH24)

S-Code	Size	Ply Rating	Type	Measuring Rim	Max. Air (PSI)		Max. Load (LBS)		Overall Diameter	Section Width	Tread Width	Tread Depth	Revs/ Mile	SLR (Inch)	Max Speed	Weight (lbs)
					S	D	S	D								
3001472	11R22.5	14	T/L	8.25	105	105	6,175	5,840	41.7	11.0	8.8	22	496	19.5	75	127
3001786	11R22.5	16	T/L	8.25	120	120	6,610	6,005	41.7	11.0	8.8	22	495	19.5	75	127
3001787	11R24.5	14	T/L	8.25	105	105	6,610	6,005	43.7	11.3	8.8	22	474	20.3	75	130
3001788	11R24.5	16	T/L	8.25	120	120	7,160	6,610	43.7	11.3	8.8	22	473	20.3	75	130
3001630	295/75R22.5	14	T/L	8.25	110	110	6,175	5,675	40.4	11.3	8.8	22	510	18.9	75	118
3001628	285/75R24.5	14	T/L	8.25	110	110	6,175	5,675	41.6	11.3	8.8	22	495	19.6	75	119

• Use inflation pressure specifications on vehicle tire placard.
• Tire construction and material specifications subject to change without notice or obligation.

OE Manufacturer Partner



Recommended Vehicle Types & Position



AH37



Regional Haul / All Position

Approved for SmartWay & CARB

The AH37 is a multipurpose performance tire structurally designed for longer tread life, fuel efficiency, and durability in intense driving conditions. The optimized footprint offers improved traction and mileage performance for a smoother ride and better handling. An enhanced siping design displaces water for outstanding road grip in adverse weather conditions.



Sizes & Specifications (Pattern Code: AH37)

S-Code	Size	Ply Rating	Type	Measuring Rim	Max. Air (PSI)		Max. Load (LBS)		Overall Diameter	Section Width	Tread Width	Tread Depth	Revs/ Mile	SLR (Inch)	Max Speed	Weight (lbs)
					S	D	S	D								
3002448	10R22.5	14	T/L	7.50	115	115	5,675	5,355	40.0	10.0	7.6	16	516	18.8	75	99
3002162	11R22.5	14	T/L	8.25	105	105	6,175	5,840	41.5	11.1	8.3	20	499	19.4	75	122
3002163	11R22.5	16	T/L	8.25	120	120	6,610	6,005	41.5	11.1	8.3	20	498	19.4	75	122
3002444	11R24.5	14	T/L	8.25	105	105	6,610	6,005	43.5	11.1	8.3	20	478	20.3	75	129
3002445	11R24.5	16	T/L	8.25	120	120	7,160	6,610	43.5	11.1	8.3	20	476	20.4	75	129
3002449	12R22.5	16	T/L	9.00	120	120	7,390	6,780	42.7	12.0	8.5	19	484	19.9	75	138
* 3002450	255/70R22.5	16	T/L	7.50	120	120	5,510	5,070	36.7	9.9	7.8	18	560	17.2	75	94
3002452	275/70R22.5	18	T/L	8.25	131	131	6,940	6,395	37.9	11.0	8.9	19	545	17.6	75	109
3002446	295/75R22.5	14	T/L	8.25	110	110	6,175	5,675	40.3	11.7	8.3	20	513	18.8	75	116
3002512	295/75R22.5	16	T/L	8.25	120	120	6,610	6,005	40.3	11.7	8.3	20	512	18.8	75	116
3002447	285/75R24.5	14	T/L	8.25	110	110	6,175	5,675	41.5	11.3	8.3	20	498	19.4	75	123

• Use inflation pressure specifications on vehicle tire placard.
• Tire construction and material specifications subject to change without notice or obligation.
* 3002450 is the only size M+S rated.

OE Manufacturer Partner



Recommended Vehicle Types & Position

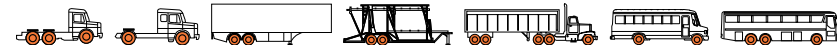

DH06



Premium Deep - Open Shoulder / Drive Position

Developed for exceptional grip and control while maximizing casing life cycle mileage. Improved and deeper tread block design allows outstanding performance in rain, mud, and snow conditions.



Sizes & Specifications (Pattern Code: DH06)

S-Code	Size	Ply Rating	Type	Measuring Rim	Max. Air (PSI)		Max. Load (LBS)		Overall Diameter	Section Width	Tread Width	Tread Depth	Revs/ Mile	SLR (Inch)	Max Speed	Weight (lbs)
					S	D	S	D								
3000844	11R22.5	14	T/L	8.25	105	105	6,175	5,840	42.1	11.1	8.7	28	496	19.7	75	129
3001546	11R22.5	16	T/L	8.25	120	120	6,610	6,005	42.1	11.1	8.7	28	494	19.7	75	129
3001489	11R24.5	14	T/L	8.25	105	105	6,610	6,005	44.1	11.1	8.7	28	474	20.6	75	138
3001488	11R24.5	16	T/L	8.25	120	120	7,160	6,610	44.1	11.1	8.7	28	473	20.6	75	138
3001635	295/75R22.5	14	T/L	8.25	110	110	6,175	5,675	40.8	11.3	9.1	28	509	19.1	75	124
3000993	285/75R24.5	14	T/L	8.25	110	110	6,175	5,675	42.0	11.2	9.0	28	494	19.7	75	133

• Use inflation pressure specifications on vehicle tire placard.
• Tire construction and material specifications subject to change without notice or obligation.

OE Manufacturer Partner



Recommended Vehicle Types & Position

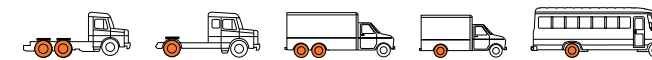

DH37



Super Traction / Drive Position

Approved for SmartWay & CARB

The DH37 is designed for extreme mileage and excellent traction in all road conditions. The large footprint and aggressive tread design allows outstanding performance in rain, mud and snow conditions.



Sizes & Specifications (Pattern Code: DH37)

S-Code	Size	Ply Rating	Type	Measuring Rim	Max. Air (PSI)		Max. Load (LBS)		Overall Diameter	Section Width	Tread Width	Tread Depth	Revs/ Mile	SLR (Inch)	Max Speed	Weight (lbs)
					S	D	S	D								
3003276	10R22.5	14	T/L	7.50	115	115	5,675	5,355	40.4	9.9	7.5	22	514	19.0	75	106
3002164	11R22.5	14	T/L	8.25	105	105	6,175	5,840	41.9	11.3	8.7	26	497	19.6	75	130
3002165	11R22.5	16	T/L	8.25	120	120	6,610	6,005	41.9	11.3	8.7	26	496	19.6	75	130
3002490	11R24.5	14	T/L	8.25	105	105	6,610	6,005	44.0	11.1	8.7	26	473	20.5	75	138
3002491	11R24.5	16	T/L	8.25	120	120	7,160	6,610	44.0	11.1	8.7	26	472	20.6	75	138
3003184	255/70R22.5	16	T/L	7.50	120	120	5,510	5,070	36.9	9.9	8.2	23	558	17.3	75	97
3002493	295/75R22.5	14	T/L	8.25	110	110	6,175	5,675	40.7	11.6	8.7	26	509	19.0	75	124
3002494	285/75R24.5	14	T/L	8.25	110	110	6,175	5,675	41.9	11.3	8.7	26	494	19.7	75	132

• Use inflation pressure specifications on vehicle tire placard.
• Tire construction and material specifications subject to change without notice or obligation.

OE Manufacturer Partner



Recommended Vehicle Types & Position

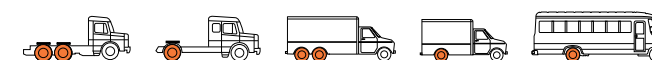

Regional Haul

SMART FLEX TH31



Low Profile / Trailer Position

The TH31 is designed with a low rolling resistance coefficient in order to provide the customer with exceptional fuel performance. The TH31 also incorporates a slanted groove design which helps prevent tire chunking over time. The TH31 has a special **CHIP AND CUT COMPOUND** for outstanding durability.



Sizes & Specifications (Pattern Code: TH31)

S-Code	Size	Ply Rating	Type	Measuring Rim	Max. Air (PSI)		Max. Load (LBS)		Overall Diameter	Section Width	Tread Width	Tread Depth	Revs/Mile	SLR (Inch)	Max Speed	Weight (lbs)
					S	D	S	D								
3003744	215/75R17.5	16	T/L	6.00	123	123	4,805	4,540	30.5	8.4	7.3	15	672	14.2	65	64
3003745	235/75R17.5	18	T/L	6.75	127	127	6,005	5,675	31.5	9.4	8.6	16	653	14.5	65	72
3003746	245/70R17.5	18	T/L	7.50	127	127	6,005	5,675	31.5	9.8	8.6	16	651	14.5	65	72
* 3003528	255/70R22.5	16	T/L	7.50	120	120	5,510	5,070	36.6	9.8	8.0	17	562	17.1	75	93

• Use inflation pressure specifications on vehicle tire placard. • Tire construction and material specifications subject to change without notice or obligation.
* 4 Grooves: 255/70R22.5 only, not 3PMSF

Recommended Vehicle Types & Position



Pickup & Delivery

SMART FLEX AH35



Optimized Design for Regional Haul Pick-up & Delivery / All Position

Unique groove design for multi performance provides outstanding traction and drainage performance on long and regional haul multi-applications. The combination of multi 3 dimensional siping provides excellent traction leading to an enhanced driving performance.



Sizes & Specifications (Pattern Code: AH35)

S-Code	Size	Ply Rating	Type	Measuring Rim	Max. Air (PSI)		Max. Load (LBS)		Overall Diameter	Section Width	Tread Width	Tread Depth	Revs/Mile	SLR (Inch)	Max Speed	Weight (lbs)
					S	D	S	D								
3003086	215/75R17.5	14	T/L	6.00	102	102	3,750	3,530	30.5	8.5	7.4	16	679	14.1	75	63
* 3002583	235/75R17.5	14	T/L	6.75	110	110	4,410	4,190	31.4	9.4	8.4	15	660	14.6	75	68
3003268	235/75R17.5	16	T/L	6.75	110	110	4,410	4,190	31.4	9.4	8.4	15	660	14.6	75	66
3002622	225/70R19.5	14	T/L	6.75	110	110	3,970	3,750	32.2	8.9	7.4	17	640	15.0	87	67
3002624	245/70R19.5	16	T/L	7.50	120	120	5,070	4,850	33.3	9.8	8.0	17	619	15.5	81	77
3002635	265/70R19.5	14	T/L	7.50	110	110	5,510	5,205	34.3	10.1	8.7	17	604	15.8	81	87
3002660	8R19.5	12	T/L	6.00	110	110	3,525	3,305	33.6	8.0	5.4	16	613	15.8	75	62

• Use inflation pressure specifications on vehicle tire placard.
• Tire construction and material specifications subject to change without notice or obligation.
* Discontinued Q2 2022

Recommended Vehicle Types & Position



OE Manufacturer Partner



SMART FLEX DH35



All Weather Pick-Up & Delivery / Drive Position

The DH35 is designed with fuel efficiency, high mileage and powerful traction in mind. Thanks to its three dimensional siping technology and its wave shaped grooves, the tire is equipped with the M+S (Mud & Snow) and snowflake symbol providing excellent winter weather performance without neglecting summer conditions.



Sizes & Specifications (Pattern Code: DH35)

S-Code	Size	Ply Rating	Type	Measuring Rim	Max. Air (PSI)		Max. Load (LBS)		Overall Diameter	Section Width	Tread Width	Tread Depth	Revs/Mile	SLR (Inch)	Max Speed	Weight (lbs)
					S	D	S	D								
3003611	225/70R19.5	14	T/L	6.75	110	110	3,970	3,750	32.2	8.8	7.2	17	641	15.1	87	66
3003716	245/70R19.5	16	T/L	7.50	120	120	5,070	4,850	33.2	9.9	8.8	17	622	15.5	81	77
3002700	265/70R19.5	14	T/L	7.50	110	110	5,070	4,675	34.3	10.2	9.3	16	607	15.8	81	89

• Use inflation pressure specifications on vehicle tire placard.
• Tire construction and material specifications subject to change without notice or obligation.

Recommended Vehicle Types & Position

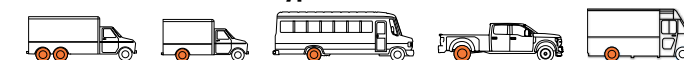

OE Manufacturer Partner



Pickup & Delivery

DH07



Pick-up & Delivery / Drive Position

A Drive axle position tire for medium and long haul service. Structurally designed for improved durability, ride, and handling performance.



Sizes & Specifications (Pattern Code: DH07)

S-Code	Size	Ply Rating	Type	Measuring Rim	Max. Air (PSI)		Max. Load (LBS)		Overall Diameter	Section Width	Tread Width	Tread Depth	Revs/ Mile	SLR (Inch)	Max Speed	Weight (lbs)
					S	D	S	D								
3001929	225/70R19.5	14	T/L	6.75	110	110	3,970	3,750	32.4	8.9	7.2	18	642	15.1	87	68
3002314	245/70R19.5	16	T/L	7.50	120	120	4,805	4,540	33.4	9.4	8.1	19	620	15.5	81	76
3002313	265/70R19.5	14	T/L	7.50	110	110	5,070	4,675	34.5	10.2	8.7	20	602	16.0	81	88

• Use inflation pressure specifications on vehicle tire placard. • Tire construction and material specifications subject to change without notice or obligation.

Recommended Vehicle Types & Position



SMART City AU04



City Bus / All Position

The AU04 is designed to be utilized in a urban city bus application. The tire utilizes its three-dimensional siping technology in order to increase tread block stiffness while also allowing for excellent handling and traction performance. This feature also helps prevent heel and toe wear, which is an essential feature in an environment that requires stop and go driving habits.



Sizes & Specifications (Pattern Code: AU04)

S-Code	Size	Ply Rating	Type	Measuring Rim	Max. Air (PSI)		Max. Load (LBS)		Overall Diameter	Section Width	Tread Width	Tread Depth	Revs/ Mile	SLR (Inch)	Max Speed	Weight (lbs)
					S	D	S	D								
* 3002707	305/70R22.5	20	T/L	9.00	130	130	8,050	7,390	39.5	12.0	9.8	22	521	18.3	68	134

• Use inflation pressure specifications on vehicle tire placard. • Tire construction and material specifications subject to change without notice or obligation.
 * Discontinued Q2 2022 • AU04 not for use on RV

Recommended Vehicle Types & Position



Mixed Service

SMART WORK AM15(+)



Wide Base / All Position

The AM15(+) is built for strength, traction and long life. Special **CHIP AND CUT COMPOUND** to enhance durability for severe conditions. The wider, deeper grooves with enhanced stone ejector platforms will prevent stone drilling and maximize removal mileage. Enhanced tread compounding and four-belt structure yield outstanding durability. Applied tie bars prevent irregular wear and reduce noise.



Sizes & Specifications (Pattern Code: AM15)

S-Code	Size	Ply Rating	Type	Measuring Rim	Tire Single		Overall Diameter	Section Width	Tread Width	Tread Depth	Revs/ Mile	SLR (Inch)	Max Speed	Weight (lbs)
					Max. Air (PSI)	Max. Load (LBS)								
3001934	425/65R22.5	20	T/L	13.00	120	11,400	44.7	16.5	12.8	23	462	20.6	65	205
3002160	445/65R22.5	20	T/L	14.00	130	12,800	45.9	17.5	13.9	24	449	21.2	68	220

Sizes & Specifications (Pattern Code: AM15+)

S-Code	Size	Ply Rating	Type	Measuring Rim	Tire Single		Overall Diameter	Section Width	Tread Width	Tread Depth	Revs/ Mile	SLR (Inch)	Max Speed	Weight (lbs)
					Max. Air (PSI)	Max. Load (LBS)								
3002813	385/65R22.5	18	T/L	11.75	120	9,370	42.5	14.9	12.0	23	485	19.6	75	179

• Use inflation pressure specifications on vehicle tire placard. • Tire construction and material specifications subject to change without notice or obligation.

Recommended Vehicle Types & Position



AH32

Wide Base Rib / All Position

The AH32 includes features best suited for regional mixed service and waste haul applications. The tire includes Hankook's innovative compound to allow for better durability and longer lasting tread life. It also includes asymmetrical grooves which help prevent stone drilling over the course of the tire's life.



Sizes & Specifications (Pattern Code: AH32)

S-Code	Size	Ply Rating	Type	Measuring Rim	Tire Single		Overall Diameter	Section Width	Tread Width	Tread Depth	Revs/ Mile	SLR (Inch)	Max Speed	Weight (lbs)
					Max. Air (PSI)	Max. Load (LBS)								
3003169	385/65R22.5	18	T/L	11.75	120	9,370	42.6	15.0	12.1	21	481	19.8	75	177
3003520	425/65R22.5	20	T/L	12.25	120	11,400	44.5	16.3	12.3	20	463	20.4	75	188

• Use inflation pressure specifications on vehicle tire placard. • Tire construction and material specifications subject to change without notice or obligation.

Recommended Vehicle Types & Position



SMART WORK DM09



On & Off Road / Drive Position

The DM09 is designed with an interlocking tread pattern which delivers great traction and performance in wet and muddy conditions. Its directional design also provides excellent handling.



Sizes & Specifications (Pattern Code: DM09)

S-Code	Size	Ply Rating	Type	Measuring Rim	Max. Air (PSI)		Max. Load (LBS)		Overall Diameter	Section Width	Tread Width	Tread Depth	Revs/ Mile	SLR (Inch)	Max Speed	Weight (lbs)
					S	D	S	D								
* 3002891	11R22.5	16	T/L	8.25	120	120	6,610	6,005	42.2	11.2	9.6	30	493	19.8	68	142
3003591	11R24.5	16	T/L	8.25	120	120	7,160	6,610	44.0	11.3	9.6	29	471	20.7	65	150
3002801	315/80R22.5	20	T/L	9.00	130	130	9,090	8,270	43.0	12.4	10.7	27	482	19.9	68	168

• Use inflation pressure specifications on vehicle tire placard. • Tire construction and material specifications subject to change without notice or obligation.

* 3002891 not 3PMSF

Recommended Vehicle Types & Position



DM04



Off Road / Drive Position

Engineered primarily for off road conditions, the DM04 is a drive axle traction radial with deep, wide treads for high mobility. Powerful construction ensures durability and long life. An open shoulder offers maneuvering while large tread blocks and special compound resist cuts and penetrations. A rugged, four steel belt structure allows maximum loads and high mileage.



Sizes & Specifications (Pattern Code: DM04)

S-Code	Size	Ply Rating	Type	Measuring Rim	Max. Air (PSI)		Max. Load (LBS)		Overall Diameter	Section Width	Tread Width	Tread Depth	Revs/ Mile	SLR (Inch)	Max Speed	Weight (lbs)
					S	D	S	D								
3000140	11R22.5	16	T/L	8.25	120	120	6,610	6,005	42.3	11.1	8.7	31	490	19.8	65	136
3000920	11R24.5	16	T/L	8.25	120	120	7,160	6,610	44.1	11.1	8.5	29	471	20.6	65	140

• Use inflation pressure specifications on vehicle tire placard. • Tire construction and material specifications subject to change without notice or obligation.

Recommended Vehicle Types & Position



SMART WORK AM09(+)



On & Off Road / All Position

Designed for on and off road applications, the SmartWork AM09(+) is built with polygonal blocks and an aggressive groove design for toughness on-site and stability on the road. The **CHIP AND CUT COMPOUND** is engineered to withstand rugged driving conditions. A wide tread provides stability and uniformity, delivering outstanding handling performance and improved tread life. The enhanced design contributes to expulsion of stones and debris.



Sizes & Specifications (Pattern Code: AM09)

S-Code	Size	Ply Rating	Type	Measuring Rim	Max. Air (PSI)		Max. Load (LBS)		Overall Diameter	Section Width	Tread Width	Tread Depth	Revs/ Mile	SLR (Inch)	Max Speed	Weight (lbs)
					S	D	S	D								
3002703	11R22.5	16	T/L	8.25	120	120	6,610	6,005	41.7	11.3	8.8	24	494	19.5	65	127
* 3002557	11R24.5	16	T/L	8.25	120	120	7,160	6,610	43.7	11.3	8.8	24	472	20.2	65	138
3002698	12R22.5	16	T/L	9.00	120	120	7,390	6,780	42.9	12.0	9.2	24	483	20.0	65	149
* 3003804	255/70R22.5	16	T/L	7.50	120	120	5,510	5,070	36.7	9.9	8.3	19	559	16.9	75	94

Sizes & Specifications (Pattern Code: AM09+)

S-Code	Size	Ply Rating	Type	Measuring Rim	Max. Air (PSI)		Max. Load (LBS)		Overall Diameter	Section Width	Tread Width	Tread Depth	Revs/ Mile	SLR (Inch)	Max Speed	Weight (lbs)
					S	D	S	D								
* 3002789	315/80R22.5	20	T/L	9.00	130	130	10,000	9,090	42.6	12.5	10.4	22	485	19.6	65	157

* 4 Grooves: 315/80R22.5 AM09+ only • Use inflation pressure specifications on vehicle tire placard.

• Tire construction and material specifications subject to change without notice or obligation.

* not 3PMSF

OE Manufacturer Partner



Recommended Vehicle Types & Position



e³ WIDE DL21



Ultra Wide Base / Drive Position

Approved for SmartWay & CARB

The e3 WIDE DL21 delivers a smooth and comfortable ride. The tire utilizes its 3-dimensional siping design along with the closed shoulder design in order to increase fuel efficiency and tread wear.



Sizes & Specifications (Pattern Code: e³ WIDE DL21)

S-Code	Size	Ply Rating	Type	Measuring Rim	Tire Single		Overall Diameter	Section Width	Tread Width	Tread Depth	Revs/ Mile	SLR (Inch)	Max Speed	Weight (lbs)
					Max. Air (PSI)	Max. Load (LBS)								
3003449	445/50R22.5	20	T/L	14.00	120	10,200	40.3	17.4	15.7	24	511	18.6	75	194

• Use inflation pressure specifications on vehicle tire placard. • Tire construction and material specifications subject to change without notice or obligation.

Recommended Vehicle Types & Position

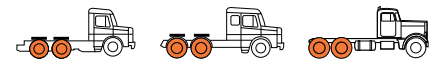

e³ WIDE TL21

Ultra Wide Base / Trailer Position

Approved for SmartWay & CARB

The e3 WIDE TL21 is a tire that can go the distance while increasing fuel efficiency. It uses three-dimensional siping technology to improve traction while also reducing tire wear. Hankook's Spiral-Coil Technology provides a stabilized footprint and strengthened casing durability throughout the life of the tire.



Sizes & Specifications (Pattern Code: e³ WIDE TL21)

S-Code	Size	Ply Rating	Type	Measuring Rim	Tire Single		Overall Diameter	Section Width	Tread Width	Tread Depth	Revs/ Mile	SLR (Inch)	Max Speed	Weight (lbs)
					Max. Air (PSI)	Max. Load (LBS)								
3003411	445/50R22.5	20	T/L	14.00	120	10,200	39.7	17.4	15.7	16	516	18.3	75	177

• Use inflation pressure specifications on vehicle tire placard. • Tire construction and material specifications subject to change without notice or obligation.

Recommended Vehicle Types & Position

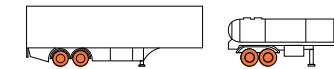

e³ WIDE DL12



Long & Regional Haul/ Drive Position

Approved for SmartWay & CARB

The e3 WIDE DL12 is engineered to provide excellent traction capabilities throughout the entire life of the tire utilizing its 3-dimensional siping technology as well as its semi open shoulder design. The tire also delivers less rolling resistance in order to allow for increased mileage and better fuel efficiency.



Sizes & Specifications (Pattern Code: e³ WIDE DL12)

S-Code	Size	Ply Rating	Type	Measuring Rim	Tire Single		Overall Diameter	Section Width	Tread Width	Tread Depth	Revs/ Mile	SLR (Inch)	Max Speed	Weight (lbs)
					Max. Air (PSI)	Max. Load (LBS)								
3002277	445/50R22.5	20	T/L	14.00	120	10,200	40.5	17.4	15.7	27	510	18.6	75	199

• Use inflation pressure specifications on vehicle tire placard. • Tire construction and material specifications subject to change without notice or obligation.

Recommended Vehicle Types & Position

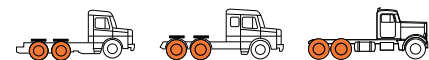

TBR Product Positioning Map

Comparison Chart

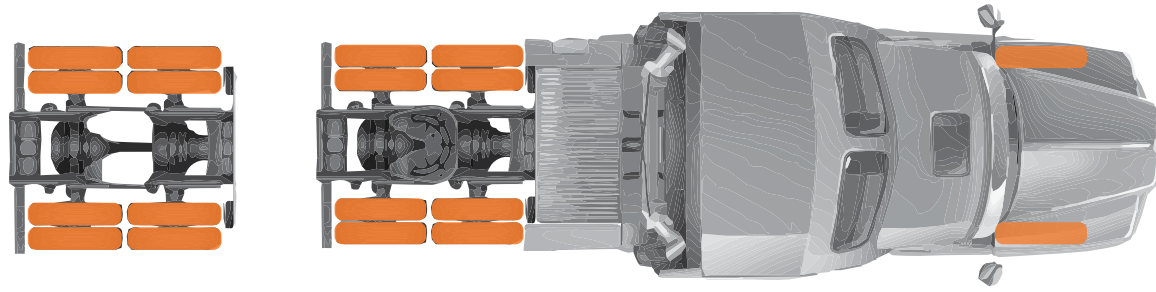

Trailer	Drive	All/Steer	
 e3 MAX TL21	 e3 MAX DL21 DL11 SMART DL12 SMART DL15(+)	 e3 MAX AL21 SMART AL22 **	Long Haul
 SMART TH31	 DH06 DH37	 AH24 AH37	Regional Haul
	 DH07 SMART DH35	 SMART AU04 * SMART AH35	Urban/Pickup & Delivery
	 DM04 (Off Road) SMART DM09	 SMART AM15(+)* SMART AM09(+) AH32	Mixed Service / On/Off Road
 e3 WIDE TL21	 e3 WIDE DL21 e3 WIDE DL12		USS

		HANKOOK driving emotion	Michelin	Bridgestone	Goodyear	Yokohama	Continental
Long Haul	AL21	X Line Energy Z	R283s Ecopia	Endurance LHS	101ZL Spec-2	EcoPlus HS3	
	DL21	XDA5+	M760 Ecopia	Endurance LHD	712L	HDL2	
	*** DL15(+)	X Multi Energy D	M760 Ecopia	Endurance LHD	709ZL	HDL2 DL Eco Plus	
	DL12	XDN2	M760 Ecopia	Endurance LHD	SY767	Hybrid HD3	
	DL11	X Line Energy D	M726 ELA	Endurance LHD	TY517 MC2	HDL2	
	TL21	X Line Energy T	R123 Ecopia	G316 LHT Fuel Max	Bluearth 109L	Eco Plus HT3	
	**AL22	X Line Energy Z Coach	M760 Ecopia	G670 RV MRT, G291	104ZR Spec-2	Coach HA3	
Regional Haul	AH24	XZE2	R268 Ecopia	Endurance RSA	108R	HSL 3	
	AH37	XZE2	R250ED	Endurance RSA	RY023	HSR2 SA	
	DH06	XDS(2)	M770	G182 RSD	715R	HDR2	
	DH37	XDS(2)	M799	G622 RSD	709ZL	HDR2 Eco Plus	
	TH31	XZE	-	G316 LHT	RY023	Eco Plus HT3	
Urban/Pickup & Delivery	AH35	XZE	R238	G647 RSS	104ZR	HSL 3	
	DH35	XDS2	M724F	G622 RSD ULT	TY287 / TY303	Hybrid HD3	
	DH07	XDS2	M724F, M729F	G622 RSD	TY303	Hybrid HD3	
	* AU04	X InCity Z	R227F	G291	-	Urban HA3	
Mixed	AM15(+)	XZY3 Wide Base	M864	G296 MSA	MY507A	HAC 3	
	AH32	XFE Wide Base	M870	G296 MSA	RY253	HTR2	
	DM09	X Works Z	L320, M775	Workhorse MSD	-	HDO	
	DM04	X Works XDY	L320, M775	Workhorse MSD	LY053	HDC1 HT	
	AM09(+)	X Works Z	M843, M853	Workhorse MSA, Endurance WHA	504C, MY627W Spec-2	HSC 3	
USS	e3 WIDE DL21	X ONE Line Energy D	Greatec M835A Ecopia	Fuel Max SSD	Bluearth 709L UWB	HDL2 Eco Plus	
	e3 WIDE DL12	X ONE Line Grip D	-	-	902L UWB	-	
	e3 WIDE TL21	X One Line Energy T2	Greatec R197 Ecopia	Fuel Max SST	Bluearth 109L UWB	HTL1	

TBR Tire Reference Chart

SIZE	Long Haul								Regional Haul				
	AL21	AL22***	DL11	DL12	DL15*	DL15+**	DL21	TL21	AH24	AH37	DH06	DH37	TH31
8.R19.5													
10R22.5										16 (G)		22 (G)	
11R22.5	19 (G,H)		26 (G,H)	28 (G,H)	26 (G,H)		30 (G,H)	12 (G)	22 (G,H)	20 (G,H)	28 (G,H)	26 (G, H)	
12R22.5										19 (H)			
11R24.5	19 (G)		26 (G,H)	28 (G,H)	26 (G,H)		30 (G,H)	12 (G)	22 (G,H)	20 (G,H)	28 (G,H)	26 (G, H)	
215/75R17.5													15 (H)
235/75R17.5													16 (J)
245/70R17.5													16 (J)
225/70R19.5													
245/70R19.5													
265/70R19.5													
255/70R22.5										18 (H)		23 (H)	17 (H)
275/70R22.5										19 (J)			
295/75R22.5	19 (G,H)		26 (G)	28 (G)	26 (G)	25(G)	30 (G)	12 (G)	22 (G)	20 (G,H)	28 (G)	26 (G)	
305/70R22.5													
315/80R22.5		18 (L)											
285/75R24.5	19 (G)		26 (G)	28 (G)	26 (G)		30 (G)	12 (G)	22 (G)	20 (G)	28 (G)	26 (G)	
385/65R22.5													
425/65R22.5													
445/65R22.5													
445/50R22.5													

Tread Depth in 32nds and Load Range are Available

* discontinued in Q2 2022 ** new in Q2 2022

*** AL22 - Recommend Coach Bus Use Only

SIZE	Urban/Pickup				Mixed On/Off					USS		
	AU04*	AH35	DH07	DH35	AM09(+)	AH32	AM15(+)	DM04	DM09	e ³ WIDE DL12	e ³ WIDE DL21	e ³ WIDE TL21
8.R19.5		16 (F)										
10R22.5												
11R22.5					24 (H)			31 (H)	30 (H)			
12R22.5					24 (H)							
11R24.5					24 (H)			30 (H)	29 (H)			
215/75R17.5		16 (G)										
235/75R17.5		15 (G,H)*										
245/70R17.5												
225/70R19.5		17 (G)	18 (G)	17 (G)								
245/70R19.5		17 (H)	19 (H)	17 (H)								
265/70R19.5		17 (G)	20 (G)	16 (G)								
255/70R22.5					19 (H)							
275/70R22.5												
295/75R22.5												
305/70R22.5	22 (L)											
315/80R22.5					22 (L)			27 (L)				
285/75R24.5												
385/65R22.5						21 (J)	23 (J)					
425/65R22.5						20 (L)	23 (L)					
445/65R22.5							24 (L)					
445/50R22.5										27 (L)	24 (L)	16 (L)

Tread Depth in 32nds and Load Range are Available

* discontinued in Q2 2022

Important Safety Warning

For your safety and protection against serious injury or death, the following safety precaution and maintenance instruction must be observed at all times.

PREFACE

This information is provided to help Hankook Tire Truck & Bus customers achieve safe, economical use of our products and maximize tire life.

The purchase of truck and bus tires should be looked at as an investment to be protected by the thorough maintenance and care in order to produce the best return on your investment and fleet operating efficiency.

Information covered in this manual covers how to perform regular tire inspections, tire servicing and repairs as well as how to safely mount and demount tires.

Careful attention on a regular basis can provide you with added safety and economy.

We hope the information is helpful to all the tire servicemen and fleet operators.

DETERMINING TIRE SIZE

There is a lot of useful information molded into the sidewall of every tire, included are the manufacturer and tire name, section width, aspect ratio, construction, rim diameter, speed rating, load range, treadwear, temperature and traction labeling and other required designations.

CORRESPONDING SIZES FOR TUBE-TYPE AND TUBELESS

To achieve the closest match of load carrying capacity, overall diameter and section width see the following chart.

LOW PROFILE TIRES

Low profile tires are marked according to ISO standards with

Tube-Type	Tubeless
7.50 R 20	8 R 22.5
8.25 R 15	9 R 17.5
8.25 R 20	9 R 22.5
9.00 R 20	10 R 22.5
10.00 R 20	11 R 22.5
10.00 R 22	11 R 24.5
11.00 R 20	12 R 22.5
12.00 R 20	12 R 22.5

Section widths and rim diameters will vary slightly between tubeless and tube-type assemblies. While the measurements seem close, users should be careful not to confuse them.

additional symbols for load range and maximum speed.

Low profile tires provide additional benefits such as:

- Fuel savings
- Increased load carrying capacity
- Improved retreadability
- Improved cornering ability
- Braking improvement

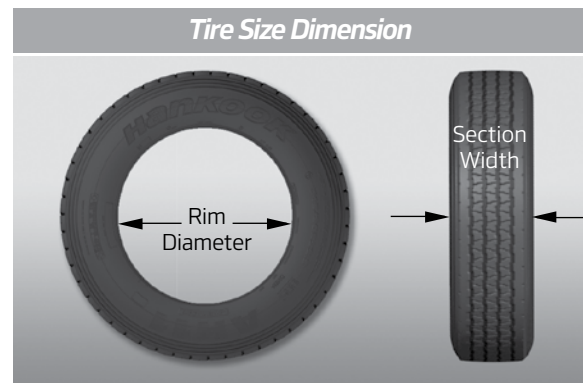

295/75 R22.5	Size Description
295	Tire section width (mm)
75	Aspect ratio (Section Height / Section width)
R	Radial structure
22.5	Rim diameter (inch)
14	Ply rating
L	Tire Max. driving speed symbol

Outside diameter comparison

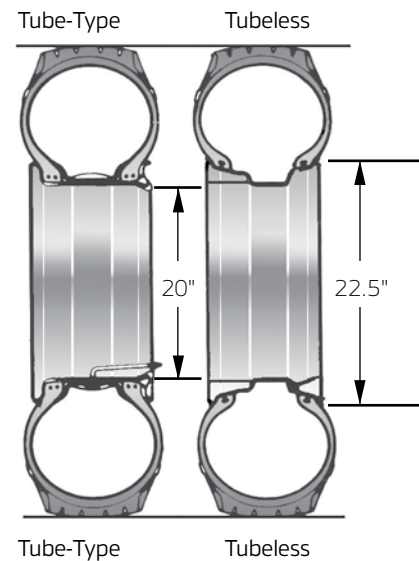

Disregarding any of the safety precautions and instructions contained in this information sheet may result in tire failure or explosion causing serious personal injury or death.

TRUCK TIRE MARKINGS

All truck tires are marked representing their structure, construction type, dimensions and manufacturer/brand. In addition, they should carry the U. S. Department of Transport code and/or ISO symbols. Below is a typical Hankook tire that illustrates the ISO markings.

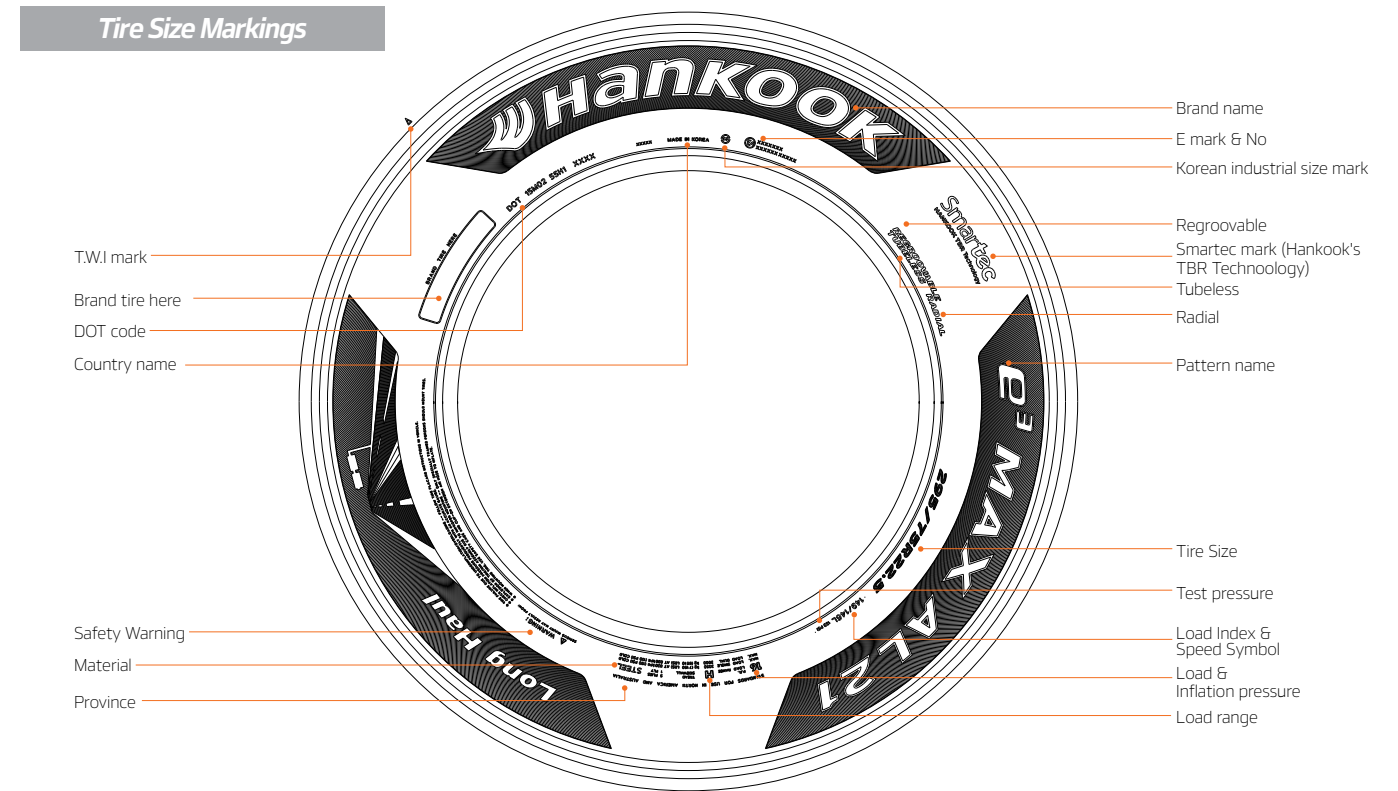

SAFETY WARNING

Serious injury may result from:

- Tire failure due to under inflation or overloading - Follow the tire placard instruction on the vehicle and check inflation pressures frequently.
- Due to improper mounting - Only specifically trained persons should mount tires. Follow all safety procedures and inflate using a safety cage and a remote clip-on extension hose.

LOAD INDEX & SPEED SYMBOL

WARNING It is recommended that the replacement tire speed rating be equal to or greater than the OEM tire speed rating. If a lower speed rated tire is selected, then the vehicle top speed becomes limited to that of the lower speed rating selected. The customer must be informed of the new speed restriction & the vehicle's handling may be adversely impacted.

When replacing tires, consult the placard or the owner's manual for correct size and speed rating. The speed rating of the replacement tires must be equal to or greater than the speed rating of the tire being replaced to maintain the speed capability of the vehicle. Speed ratings do not imply that the vehicle can be safely driven at the maximum speeds for which the tire is rated. Serious injury or death may take place if you drive your vehicle in an unsafe or unlawful manner. Hankook's speed symbol designations are verified and comply with regulatory indoor test in accordance with ECE-R30,54 test (Economic council for Europe : Procedure Load / Speed performance test for tires). These symbols are not applicable to repaired tires.

The load carrying capacity of the replacement tire must always equal or exceed the load carrying capacity of the original equipment tire. Tires that are loaded in excess of the allowable maximum load can build up heat and cause sudden air loss.

LOAD RANGE, INFLATION & SPEED ADJUSTMENTS

Load limits are fundamentally the same for tires manufactured according to American TRA, Korean KS European ETRTO and Japanese JIS standards. Load limits are affected by driving speed, the type of construction of the tire, and the position of the tire (whether it is used in single wheel or dual wheel application).

For recommendations concerning adjustments to driving speed, inflation pressures and load limit increases or decreases refer to the charts below. Also, never exceed the maximum load and inflation recommended by the rim manufacturer.

Important Safety Warning

REPLACEMENT TIRES

If mounting tires different from the size originally on the vehicle, consider the following:

LOAD CAPACITY

Tires must always have equal or greater load carrying capacity than the Original Equipment (OE) tires

TRANSMISSION RATIO

Tires with a different circumference than OE tires will affect the transmission of power.

- Smaller tires will improve acceleration but reduce top speed
- Bigger tires will reduce acceleration but increase top speed

RIM DIAMETER

When selecting smaller diameter wheels or rims, check to ensure proper brake drum clearance and sufficient ride height or ground clearance.

RIM WIDTH

The rim width must always fit in the range specified for the section width of the tire. Usually only small increases or decreases in the tire section width is permissible before requiring a change of rim widths to accommodate any change in tire section width.

DUAL-WHEEL SPACING

There is a required minimum spacing required between any dual-wheel assembly.

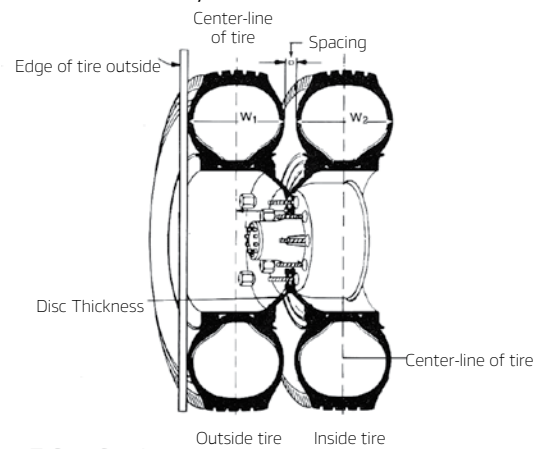

TIRE SPACING

Spacing between the tire(s) should be checked to ensure adequate clearances.

- To avoid coming in contact with any stationary parts of the vehicle such as chassis, body or undercarriage.
- To avoid hitting or contacting movable suspension parts of the vehicle such as springs or shocks.
- Generally acceptable levels of minimum clearance are 15 mm for fixed parts and 25 mm for movable parts.

NOTE: Minimum clearances may change according to vehicle classification.

TRANSVERSE SPACING

1. Transverse Clearance

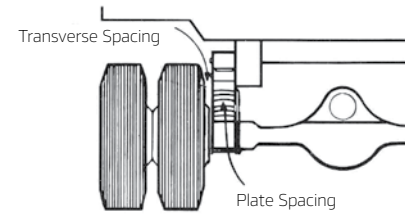

The section width of any replacement tire must also allow sufficient minimum clearance from springs.

2. Vertical Clearance

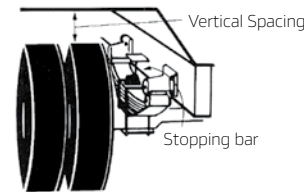

The clearance between the tire and the body and chassis must be checked to ensure sufficient clearance to avoid the tire hitting or scraping against any parts either when the suspension is loaded or unloaded.

The shock absorber and spring ratings stiffness will also affect these clearances. Clearances must be sufficient so that even under maximum suspension travel or deflection, the tires do not contact either the body panels or vehicle undercarriage.

3. Suspension Clearance

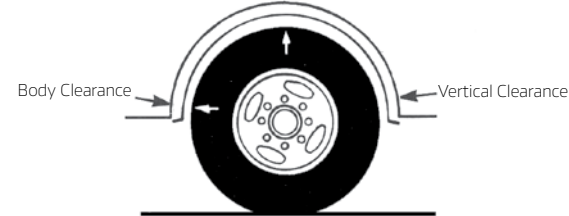

In the case of leaf springs with a swing pivot to allow wheel movement forward and backward, it is important to leave sufficient clearance to allow movement approximately one third that of the distance allowed by the swing action travel.

4. Front-Wheel Clearance

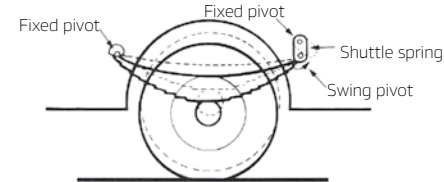

Front-wheel clearance should be checked to ensure sufficient clearance even at lock-to-lock steering positions as well as at the mid-point.

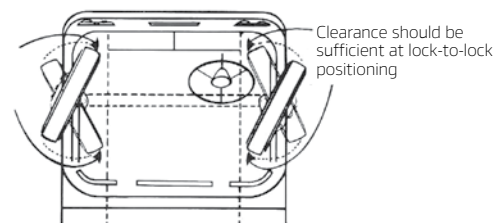

Disregarding any of the safety precautions and instructions contained in this information sheet may result in tire failure or explosion causing serious personal injury or death.

CLEARANCE CHECKS

Always check to ensure that mounted wheels allow clearance from brake drums/discs, suspension parts or steering assembly, body and other parts. Nothing should be touching either the tire or the valve and there should be a clearance margin of between 20 and 25 mm.

MATCHING DUAL-WHEEL TIRES

For vehicles using dual wheels it is important that tire circumferences be the same. This is sometimes not the case if tires are not new, of the same tread pattern or have been retreaded. Therefore use a tape measure to match the mounted and inflated tires by circumference prior to installing them on the vehicle.

- Tires must be mounted and inflated to recommended pressures before measuring circumference with a tape measure.
- In situations where they are already mounted as dual-wheels use a square rule to ensure they match in size.
- Ensure uniform sizing on a given dual-wheeled axle by using a long straight rule across the tread of the four tires

TIRE INFLATION

Measuring Circumference, diameter of dual-wheel tires

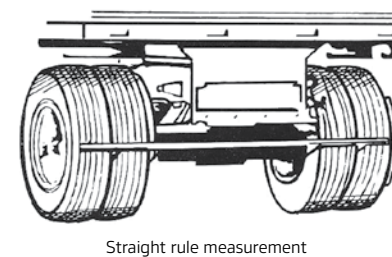
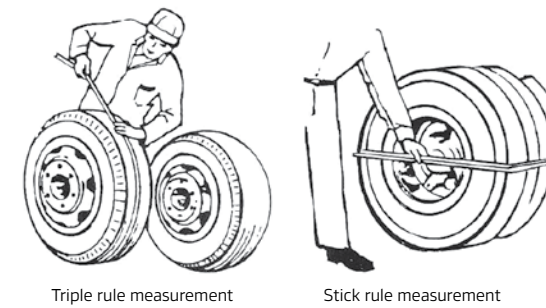

increases their temperature and the pressure inside, therefore do not decrease the pressure of a "hot" or driven tire as this may result in dangerously inadequate pressure once cooled.

For maximum efficiency it is best to maintain the tires at the recommended inflation and that inflation pressures for both sides should be equal.

It is also advisable to take into account axle load and driving conditions when setting inflations pressures. Compensation for heavier loads can be made by increasing inflation pressures, but do not exceed maximum inflation for the tire or maximum axle load.

Front steering tires may require more inflation when the vehicle is loaded in order to facilitate steering, cornering and wet traction. It is not uncommon that is 20 psi be added in the case of a 11R22.5 14PR tire on the front axle as per the following.

Example 1 If the load on the front axles is 2,245 kgs then 80 psi would be the normal recommended pressure.

However users frequently apply an added 15 to 20 psi which inflates the tires to 95 to 100 psi to assist steering, load carrying and traction while remaining within specific maximum capacity of

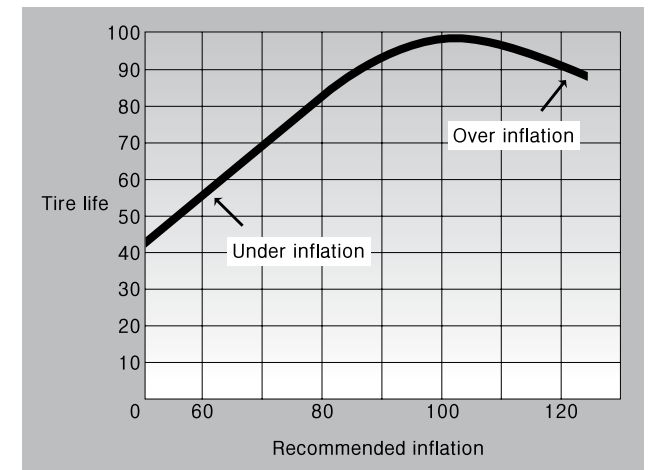

2,920 kgs at max inflation 105psi.

Example 2 If the front axle load is 2,740 kg, 105psi is recommended. A reduction in speed may be necessary along with slight over inflation (not more than 10%) to compensate for max load conditions. A Hankook Tire serviceman can provide details.

NOTE:

It is important not to exceed the maximum capacities established by the wheel manufacturers. Wheel product specification should be used in determining any recommendations.

A most important aspect of maintaining tires is proper inflation. Sufficient inflation is needed to carry the load and avoid damage. Driving with proper inflation (particularly grossly under inflated or over inflated tires is dangerous and can cause critical damage or sudden failure of the tire(s).

Proper inflation should be maintained and checked on at least a weekly basis and before long distance drives. Pressures should be checked and adjusted if necessary while the tires are cold (before they have been driven on any significant distance). Driving even a moderate distance on tires

Important Safety Warning

OVER INFLATED - UNDER INFLATED

Maintaining proper air pressure is the single most important thing drivers can do for their tires. In the span of just one month, a tire can lose 10 pounds of air pressure. It is important to check your air pressure regularly, to make sure your tires are neither under-nor over inflated.

Under-inflation is the worst enemy your tire can have. It causes increased treadwear on the outside edges (or shoulders) of the tire. It also generates excessive heat, which reduces tire durability. Finally, it reduces your fuel economy by increasing rolling resistance-soft tires make your vehicle work harder.

Over-inflation is also detrimental to the tire. Too much air pressure causes the center of the tread to bear the majority of the car's weight, which leads to faster deterioration and uneven wear. Any kind of uneven wear will shorten the life span of your tires. To find the proper air pressure for your tires, [look in the vehicles owner's manual, on the driver's side door jamb or in the glove box] and if you buy new tires, be sure to learn the correct pressure from your dealer. Check your pressure at least once a month using a good quality air gauge or stop by your local Hankook dealer and have your pressure checked and corrected.

CHECKING TIRE PRESSURE

It is important to check your vehicle's tire pressure at least once a month for the following reasons:

- Most tires may naturally lose air over time.
- Tires can lose air suddenly if you drive over a pothole, an object, or if you strike the curb while parking.
- With radial tires, it is usually not possible to determine under-inflation by visual inspection

For convenience, purchase a tire pressure gauge to keep in your vehicle. Gauges can be purchased at tire dealerships, auto supply stores, and other retail outlets. The recommended tire inflation pressure that (vehicle manufacturers provide reflects the proper psi when a tire is cold) The term cold does not relate to the outside temperature. Rather, a cold tire is one that has not been driven on for at least three hours. When you drive, your tires get warmer, causing the air pressure within them to increase. Therefore, to get an accurate tire pressure reading, you must measure tire pressure when the tires are cold or compensate for the extra pressure in warm tires.

TIRE INSPECTION

It is wise to inspect the condition of the tire whenever you check inflation. Look for any problems with the tire swells, cracks, irregularities, damage or penetration of any kind. Also inspect the wheels, valves, and valve stems for any possible damage. If found, either consult a Hankook Tire serviceman or have it repaired according to recommendations or if damage is too extensive, discard or destroy the damaged tire(s) to avoid danger of accident or injury.

SAFETY

Damage and rapid wear are frequently caused by driving conditions such as over loading, rapid stops and starting, uneven road surfaces or road debris (rocks, stones, obstacles). Slow careful driving on rough uneven roads will help prevent some of this type of damage. In addition, alignment irregularities may result from the above mentioned conditions and these should be corrected prior to any high speed or long distance driving.

TREAD DEPTH MEASUREMENT

Wear measurements should be taken at 90 degree intervals around the circumference of the tire. If two or more of the places read less than 2/32^{nds} tread deep wear the tire should be replaced. If the wear indicator bars are exposed, the tire should be replaced. It is dangerous to drive with tires that exhibit wear conditions less than the minimum. Some regions and countries have restrictions based on local conditions that require more tread (ie. a 4/32^{nds} minimum). Consult local authorities if you are in doubt.

Wear measurement

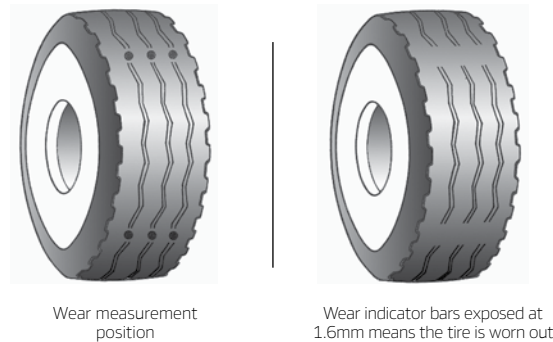

MAXIMUM LOAD

Do not overload. The loads for truck and bus tires are proportioned to inflation, speed and driving conditions. For safety, follow proper loading, inflation and moderate speeds to suit road conditions. Consult a Hankook Tire serviceman if you are not certain about max load, avoid overloading as it can result in tire damage, broken equipment or injury due to tire failure cause by over heating or excessive load beyond the tire's capabilities.

PROPER SPEED

Hankook Tire imprints the maximum recommended speed on the sidewall of radial tires in keeping with the industry standards and practices. If a tire is driven more than the max speed specified, it can create high heat within the tire that can result in tire damage or failure. Therefore it is recommended that drivers stay below the tire's recommended max speed and that they do not exceed posted speed limits. It is important that proper tire inflation is maintained at all times, but particularly in the case of highway driving where higher speeds may result in more rapid heat build up in the tire. Also, impacts with road debris and obstacles hitting the tire are more severe and damaging. Reduce speeds to avoid such hazards and to allow time to maneuver around such obstacles.

TIRE ROTATION

Tires should only be rotated when necessary or when irregular wear is experienced. Vehicle manufacture rotation pattern recommendations should be followed. There is no restriction on cross rotation. Rotating tires to spin in the opposite direction of original position can be beneficial to combat irregularly worn tires. Directional tires should be mounted in the direction of rotation.

Disregarding any of the safety precautions and instructions contained in this information sheet may result in tire failure or explosion causing serious personal injury or death.

STORAGE

Tires should be stored in a dry, well-ventilated place away from heat, direct sunlight or exposure to fuels, oils, greases or natural gas or electric charges. It is most important to avoid moisture either outside or inside the tire that can cause deterioration of the tire's casing plies which could result in sudden and dangerous failure of the tire.

Cuts or damage to the tire's surface may allow moisture and pollutants access to the tire's casing plies and belts therefore these should be dried, repaired or retreaded prior to storage.

CHAIN USAGE

Many regions, areas, states or provinces have specific regulations governing the use or restriction of tire chains. In addition you should pay particular attention to the following in situations where use of chains is permitted.

- Chains must be used only when required by weather conditions. In some cases it is required to install a chain when a warning is issued or an area is posted. Speed must be reduced when using chains. High speed and long distance driving with chains on must be avoided because it can cause serious damage to the tires or failure of the chains.
- Proper size chains should be used according to the tire size.
- Proper clearance between the chained wheels and the vehicle are required.
- The chain manufacturer's information should be followed.

TRUCK MAINTENANCE

The two major things that affect tire wear are:

- Inflation Pressure
- Vehicle Alignment

COMPONENTS OF ALIGNMENT

- Toe
- Camber
- Caster
- Ackermann
- Axle Parallelism
 - Thrust Angle
 - Scrub Angle

TOTAL VEHICLE ALIGNMENT

Definition

- The process whereby the vehicle and all the tires are traveling in the same direction .
- Steering axle alone is not sufficient.

CAMBER

The angle that the center line of the wheel is inclined from the vertical center line perpendicular to a flat road is called camber angle. If the top of the wheel leans out from the perpendicular than it is positive camber. If the top of the wheel leans in from the perpendicular than it is negative camber.

Camber is meant to compensate for the downward forces of the added load. Correct camber settings help the tire maintain firm even tread contact with the tread while the vehicle is traveling under loaded conditions. Often wear at the outside or inside edge of the tire may indicate incorrect camber setting.

- Camber is the inward or outward tilt of the steering axle tires when viewed from the front.
- Positive camber is at the top of the tie tilted out.
- Camber becomes more negative as the load increases.

TOE

POSITIVE NEGATIVE

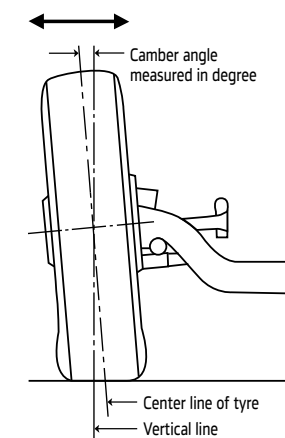

Positive camber



Negative camber



Toe refers to the inclination of the wheels of the vehicle so that the pair of front wheels (viewing from the front as per the illustration below) is close together at the front than at the rear of the wheels.

The opposite is considered to be toe-out.

The purpose of tie-in is to relieve or counteract some of the force which pulls wheel outward as they roll along the road. Proper toe-in will ensure that the rotation direction of travel are as similar as possible at driving speed.

Insufficient toe-in settings will result in steering instability.

If toe-in or toe-out is insufficient or excessive the tear wear will be effect and appear as feathering at the edges of tread.

- Toe is the inward and outward pointing of the wheels when viewed from the top of the vehicle.
- The goal is to have zero tow when the vehicle is loaded to its normal operating condition.

Damage due to contact with the vehicle

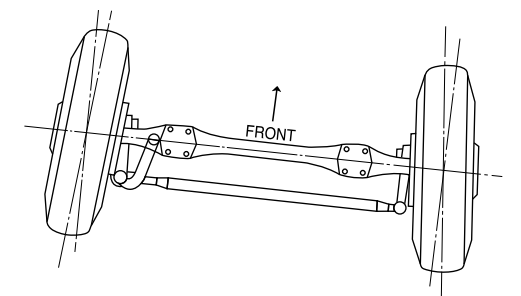

Toe-in

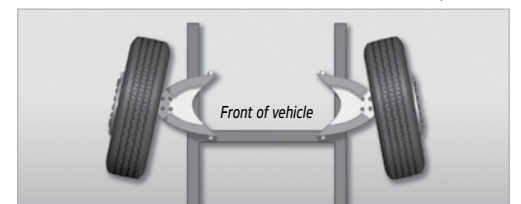

Toe-out

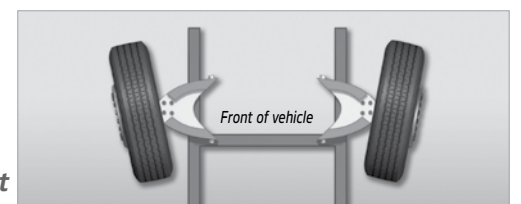

Important Safety Warning

Disregarding any of the safety precautions and instructions contained in this information sheet may result in tire failure or explosion causing serious personal injury or death.

CASTER

Caster is the condition where the king pin is inclined with the top of the pin angled rearward similar to front forks of a bicycle. Caster angled is meant to compensate for resistance which the tire(s) encounters as a result of drag forces against the road.

Caster angle should be the same for both wheels on a given axle or the result will be vibration and abnormal wear.

Too much caster will more than compensate for the amount of drag, but will create more difficult steering.

Too little caster and steering becomes light, but unstable and wanders.

Caster angle should be checked as it can be distorted by impacts on the tire or by driving in rough conditions.

- Caster is the forward or rearward tilt of the king pin of the steering axle when viewed from the side.
- Caster is generally not considered to have a great effect on tire wear.

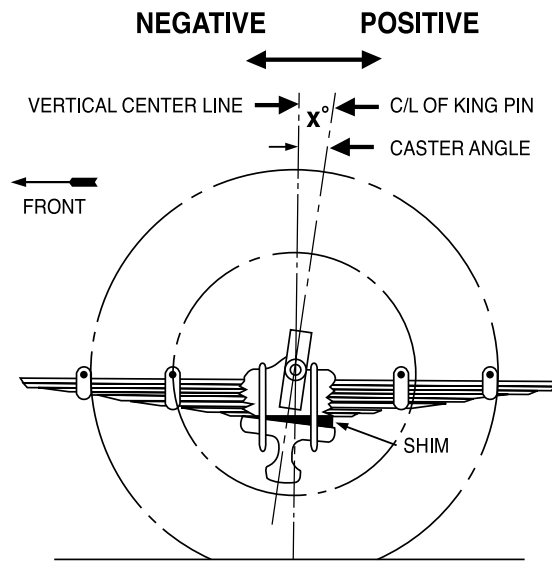

ACKERMANN

- The Ackerman Principle shows that in any turn the inside tire needs a sharper angle than the outside tire.
- The difference in turn angles between the tires is determined by the actual turn angle at the vehicle wheel base.
- Improper Ackermann causes side force, excessive scuffing, and fast or irregular wear.

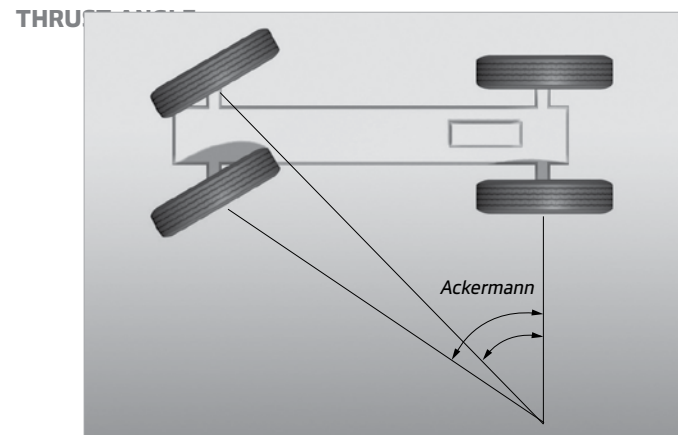

- Thrust angle is the difference between the line perpendicular to the axle and the vehicle centerline.
- Each drive axle has its own thrust angle.
- The target is to have zero thrust angle.

TANDEM SCRUB

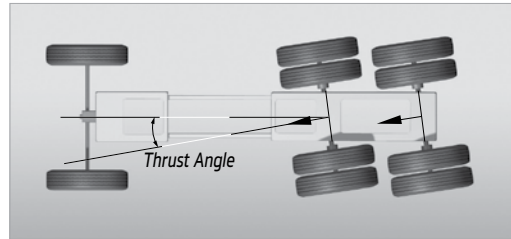

- Tandem scrub is the difference in the thrust angles of the drive axles.
- The target is zero.
- Tandem scrub errors cause constant side force on the steer tires. This leads to irregular wear.

ABNORMAL TREAD WEAR

Under inflation and over inflation of tires is the prime cause of tread wear. However there are other conditions that influence tread wear and produce irregular patterns of wear.

- Imbalance of tire or tire and wheel assembly.

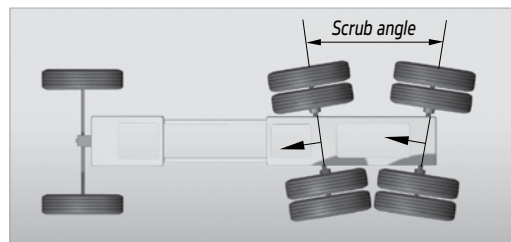

- Improper wheel alignment.
- Braking system problems that may cause wheel lock up or flat spotting.
- Bent round rims.
- Worn or damaged bearings.
- Broken or worn shock absorbers, springs or steering components.

Shoulder wear caused by wrong camber or misalignment

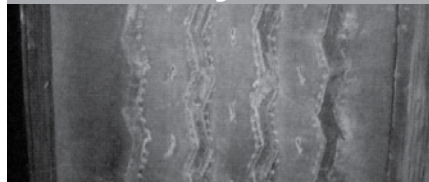

Diagonal Wear

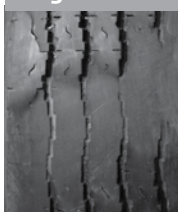

Abnormal Wear

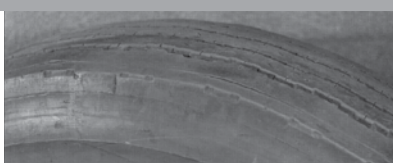

TIRE DAMAGE

With tubeless tires, it is often possible even with a slow air leak to use the tire carefully enough to get to a service center. Small punctures in the tread area, if detected early enough, can usually be repaired so as to avoid air loss and further problems. However, sufficient loss of air can cause rapid and damaging heat build up within the tire which may result in the failure or separations between the tread and carcass plies. Care should be taken to avoid getting road debris, dirt or moisture penetrating any puncture or trapped inside the tire or between the wheel rim and tire. Damaged tires should always be repaired or replaced at the nearest possible convenience to avoid further tire damage, possible tire failure, vehicle or personal injury.

Check for and correct any of the following conditions:

- Improper tire inflation
- Overloading
- Improper vehicle maintenance
- Brake system abnormalities
- Differences of tires sizes or circumferences on the same axle
- Improper mounting of tire or wheel
- Improper, worn or damaged valve
- Improper use of tube or flap

Burned Beads

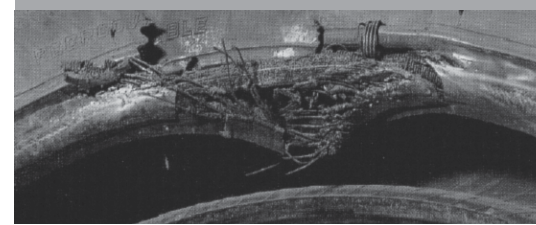

Ripped Sidewalls

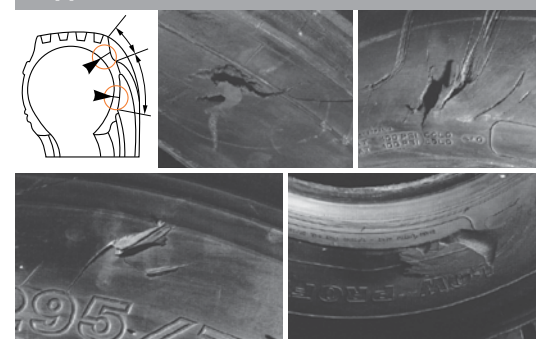

Sidewall damage due to run flat or severe under inflation



Damage due to contact with the vehicle



Flat spotting due to locked brakes

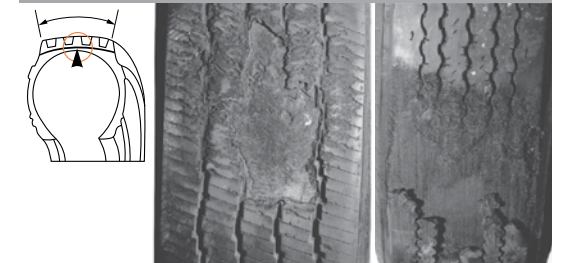

Bead damage due to curbing

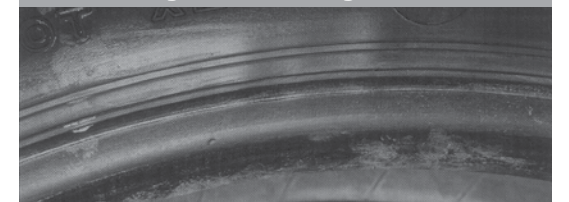

HEAT CAN DAMAGE TIRES

Under inflation, overloading, or excessive speed can cause damage because of heat build up. Tire parts such as cord, the bonding between carcass, belts, and treads can be easily damaged by excessive heat. Most tire cords lose strength at temperatures above 120° C making the tire more vulnerable to failure. Excessive heat can weaken or damage cords or rubber compounds or cause separation between the plies.

MOISTURE DAMAGE

Moisture inside the tire or penetrating through to the steel belts of a radial tire can cause rust damage to the steel cord or the rim.

Therefore always:

1. Store tires indoors in a dry place.
2. Ensure wheels, flaps, tubes, valves, and the inner tire surface are clean and dry before and during mounting.
3. Use the recommended mounting lubricant on the rim and tire bead during the mounting process.
4. Maintain inflation and keep the valve stem capped or protected so as not to allow moisture to enter the tire.

PREVENTING TIRE DAMAGE

- Proceed with caution if you have to go over a pothole or other object in the road.
- Do not run over curbs or other foreign objects in the roadway and try not to strike the curb when parking.

Important Safety Warning

Disregarding any of the safety precautions and instructions contained in this information sheet may result in tire failure or explosion causing serious personal injury or death.

TIRE SAFETY CHECKLIST

Check the tire pressure regularly (at least once a month), including the spare.

- Inspect tires for uneven wear patterns on the tread, cracks, foreign objects, or other signs of wear or trauma.
- Remove bits of glass and other foreign objects wedged in the tread.
- Make sure your tire valves have valves caps.
- Check tire pressure before going on a road trip.
- Do not overload your vehicle. Check the tire information placard or owner's manual for the maximum recommended load for the vehicle. If you are towing a trailer, remember that some of the weight of the loaded trailer is transferred to the towing vehicle.

MOUNTING & DEMOUNTING

SAFETY INSTRUCTIONS

Do not mount or demount tires without proper training. Wall charts containing mounting and demounting instructions for all highway rims should be available through your normal rim supplier.

Remove all cracked wheels from service

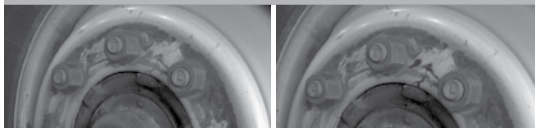

Lubricate areas shown by arrows

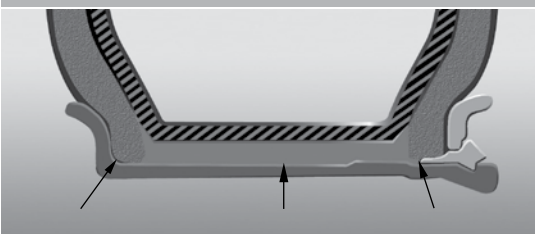

Use of GG ring to indicate correct mounting



Proper sequence for tightening stud nuts on an 8 stud system



Note: Always use a securely held safety cage and extension hose with clip on air chuck for airing the tire. Rapid air loss can propel the assembly.

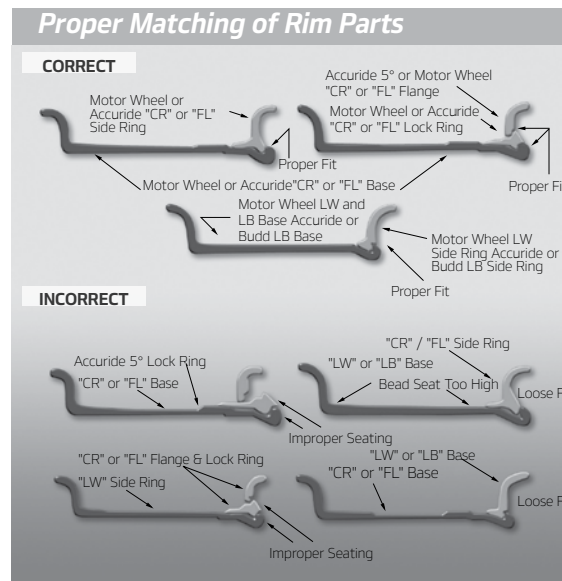
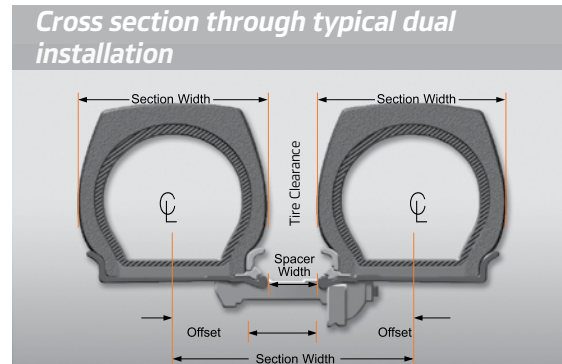

TUBE-TYPE TIRE MOUNTING

All parts should be clean and free of water or foreign matter. A new tube should be used, because reused or old tubes stretch or increase in size which can lead to problems with the tube folding, cracking or wearing too rapidly. Proper sized radial tubes should be used in radial tires. Radial tubes are designed to handle the radial profiles and flexing requirements.

WHEEL PREPARATION

For safety reasons check the following in regards to mounting and demounting tires and wheels.

- Rim diameter, rim width and flange design must be that recommended for the tire
- Rim profile must be appropriate to the type of tire (tube-type or tubeless) that is being used.
- The angle and position of the tire bead must seat properly to the rim.

Before mounting, the wheel should be inspected for any cracks, breaks, damage, misplaced parts or deformities or irregularities at the locking ring rim flange, surfaces or valve hole. Any signs of weak welds, dents, rough surfaces or dust should be corrected or a new of more suitable wheel should be used. If corroded, clean the rim with a wire brush, sand it smooth and paint it with anti-rust paint. Any dents and rough surfaces must be smoothed.

Note: Be careful to demount the tire prior to attempting any wheel repair such as hammering, heating or welding of wheels.

PROPER MOUNTING AND DEMOUNTING

Follow all mounting and demounting procedures and equipment safety cautions. Always keep tools and work areas clean and free of oil and grease.

Note: Tire mounting lubricant is necessary for mounting and demounting tires.

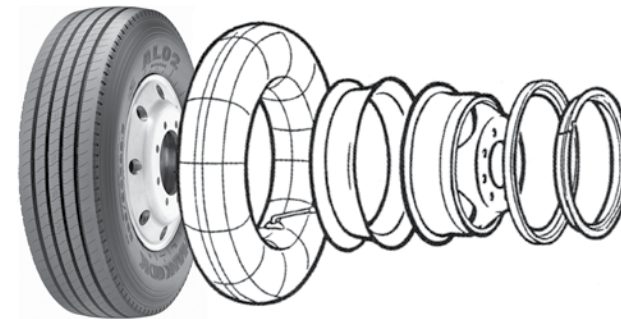

Note: Use of any improper design, size or type of tube may cause tube breakage or damage to your Hankook radial tire.

Confirm that the tube is the proper type and size with the correct valve stem type suitably fit the wheel hub and clearances for brake sand wheel parts. The valve stem should screw into the tube with a rubber bushing or washer. This should be a secure, clean attachment to the tube.



VALVE STEM ATTACHMENT

Do not screw the valve stem in the wrong direct or beyond the recommended tightness.

The step by-step mounting procedure should be followed: Insert the new tube in the dry clean tire and inflate it slightly, just until the tire becomes round. The proper sized new flap should be used. Definitely do not use used flaps that are brittle, cracked, broken or stretched.

TUBE-TYPE TIRE MOUNTING

Mount the flap inside the tire being careful not to buckle the flap edges over and under. Center the flap and position it so that the valve hole lines up. Inflate little more so that flap is held close between tire and tube. It will not conform perfectly in shape until later.

- After lubricating the rim flange, tire bead and flap where it will touch the rim.
- Slide the tire/tube/flap assembly onto the rim
- Combining the side ring and lightly rap the locking ring into proper position. Do not use excessive hammering and avoid hitting the tire.

SAFETY CAUTION

Use an accurate air gauge and an air line and a remote operating nozzle long enough to allow you a distance of personal safety from the tire assembly for the remainder of the inflation process.

Note: Do not stand in front of any wheel while inflating the tire.

- Inflate slightly and recheck to ensure the assembled parts are in proper position. Inflate slightly more and check to ensure tire bead has seated (slide over to make complete contact with the rim flange). If not, deflate, lubricate and re-try assembly.
- Release any air trapped between the tube, flap and tire by deflating and then reinflate to get proper conforming fit of the flap.

SETTING FINAL INFLATION PRESSURE

Install a new valve core each tire a new tire is mounted. Use a tire safety cage and a remote operating air nozzle. Re-check that the assembly is going together properly at every stage of the process.

Inflate in stages, re-checking that the assembly is going together properly at every stage until the recommended inflating pressure is reached. Then add a valve cap after adjusting to the final recommended pressure.



SAFETY CAGE

Note:

- Use the safety devices at all times. Do not stand in front of the tire or the valve during inflation.
- Before final inflation, check the assembly condition carefully.
- Check if there is any leakage.
- Use only the correct, clean mounting and demounting levers, paying attention that they are not oily or greasy which could cause them to slip.
- Use only the recommended equipment and do not apply excessive force or hammering.

Tire should be deflated before dismounting the wheel assembly from the vehicle. Clear away any foreign matter from the valve stem and area, prior to releasing the valve stem to let the air escape.

DEMOUNTING THREE-PIECE WHEEL ASSEMBLIES

Place the wheel assembly on firm clean ground or floor with the lock-ring side facing upward. Then use the tire demounting lever with a spoon-type tip to pry between the rim flange and the tire bead. Work around the tire operating the lever between the bead and the rim flange. Avoid operating on the same place several times. After the bead and rim separate, put the lever in the groove at the base, separate the lock-ring and remove the side ring.

Important Safety Warning

Disregarding any of the safety precautions and instructions contained in this information sheet may result in tire failure or explosion causing serious personal injury or death.

Base Part of Tubeless Rim

The Tubeless tire rim Parts marked "///" are to be cleaned and lubricated.

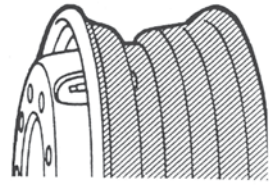

TUBELESS TIRE MOUNTING

RIM PREPARATION

- Rim must not be broken or damaged.
- Remove the rubber bushing from the valve stem hole. Inspect the valve stem for any signs of damage or wear.
- Remove rust, dirt and any foreign materials from the rim. Clean and sand smooth the area marked "///" in the above picture. If rusted, clean and repaint the rim surface to protect it from rusting.
- If required, replace any worn or damaged valve stem.
- Lubricate the inner parts of the rim surface where the tire mounts (marked "///")

TIRE PREPARATION

In the case of new tires, wipe the bead clean with a dry cloth and verify that it is not damaged, kinked, or broken. Apply the recommended lubricant to the tire bead as per the following illustration.

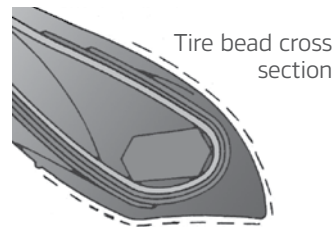

INSIDE BEAD ASSEMBLY

Lay the wheel on a clean flat surface with the valve facing upward. Work the bead over the rim flange, using your hands and knees as in the illustration below. If it is difficult to fit over the flange, use the proper tire mounting lever as per the illustration.

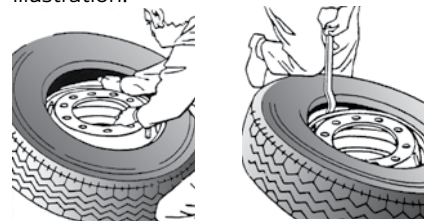

OUTSIDE BEAD ASSEMBLY

Start the outside bead placement over the outside rim flange by hand. Begin at the point where the valve stem is located. Once hand placement become difficult, use the proper tubeless tire bead mounting lever to complete the job as per the following illustrations. When mounting tires, do not use excessive force and avoid heavy tools or impacts such as hammering on the rim.

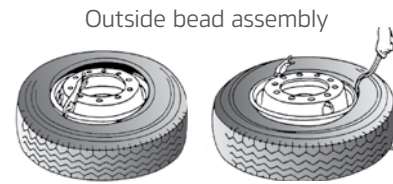

TUBELESS TIRE INFLATION

Use an inflation gauge, suitable remote air hose nozzle, and a safety cage when inflating the new mounting tire. The lubricated bead should seat firmly to the rim flange at about 10 PSI inflation. Do not stand near or in front of tire while inflating. Use the safety cage and a safe distance for your protection. If the bead fails to seat first try, then rotate the tire a few degrees around the rim, ensure the rim and bead flange is lubricated and try again. If for any reason the bead does not appear snugly and evenly seated, do not attempt to inflate further. Repeat the entire assembly process with perhaps more lubricant on the bead and rim areas.

Once the bead seats the bead and rim flange are a snug even fit all the way around. Then inflate the tire to the recommended inflation pressure to the axle load. Check that the tire or valves are not leaking and tighten on a valve cap.

TUBELESS TIRE DEMOUNTING

The tire should be completely deflated before demounting. This is done by loosening and removing the valve stem core, being careful that there is no foreign matter left in the valve and that the valve stem is not cracked or damaged. Do not stand near the valve stem during the deflation process.

BEAD DEMOUNTING

Place the tire assembly on a clean flat surface with the valve facing upward. Use a tire demounting lever

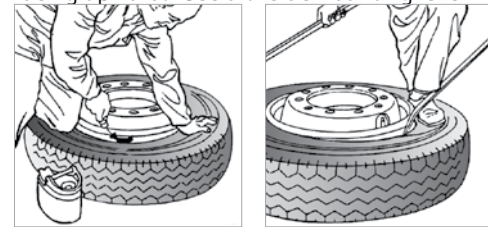

OUTSIDE BEAD DEMOUNTING

Use the tire demounting lever to pry the bead over the rim flange directly in line with the valve stem as per the following illustrations. A second lever is used about 30cm around the rim from the first to pry the bead over the flange. Repeat the process around the tire until the outside bead is fully demounted.

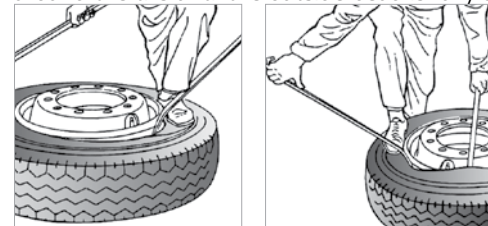

INSIDE BEAD DEMOUNTING

Turn the tire assembly over. Lubricate between the bead and the rim then insert the tip of the tire lever between the tire and rim and apply pressure. Use the second lever about 15 cm around the edge of the rim. Repeat the order until the bead is completely demounted.

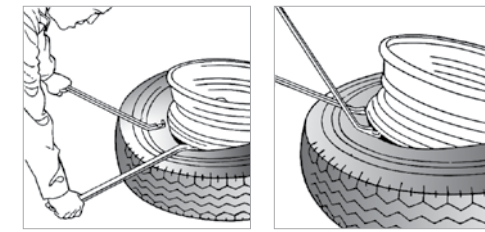

TUBELESS RIM VALVE MOUNTING

A-TYPE RIM VALVE

The valve hole in the rim must be clean, smooth and not damaged. Apply a recommended lubricant to the rubber bushing of the valve. Insert the valve stem through the rim hole, assembling the washer and lock-nut on the inside and tighten the lock-nut with a wrench so that the valve stem is secured to the rim.

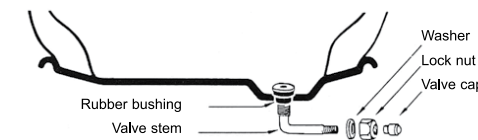

B-TYPE RIM VALVE

The valve hole in the rim must be clean and not damaged. As per the illustration below place a lubricated O-ring on the valve stem, insert the stem into the valve stem hole in the rim so that the valve stem faces perpendicular to the rim. Then tighten the lock nut with a wrench from the opposite side of the rim until the valve stem is secure.

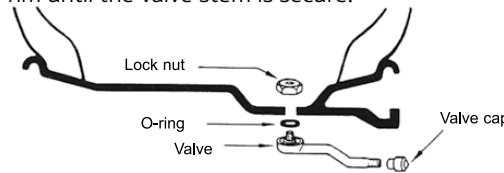

C-TYPE RIM VALVE

The valve hole in the rim must be clean, smooth and not damaged. As per the illustration below, lubricate the O-ring and insert a new valve stem through the O-ring and then through the valve stem hole in the rim from the inside. From the other side, securely hand tighten on the lock nut.

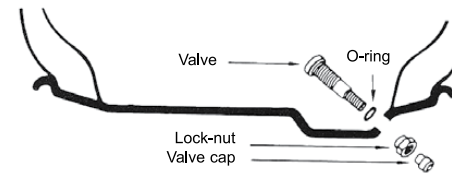

TIRE REPAIRS

Tire repairs normally made by fleet operators and tire service centers are limited to simple punctures such as nail holes. Anything more extensive, such as spot, reinforcement, or section repairs should be referred to an authorized HANKOOK retreading and repair facility. Significant cuts and cracks in the sidewall area should be spot repaired as soon as possible to prevent the need for a major section repair.

Frequent tire inspection in service is recommended. This section gives information concerning tire damage, extent, and location, to help determine whether or not section repairs are feasible.

NAIL HOLE REPAIR PROCEDURES

Radial nail hole repairs up to 3/8-inch diameter (9.5 MM) may be in the tread face as long as the nail hole is at least one-inch inside the shoulder. All injuries outside this point should be treated as a section repair.

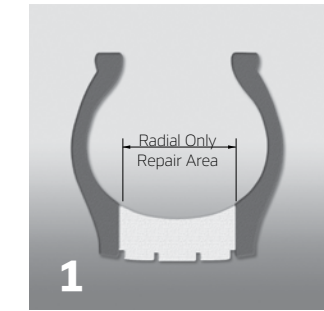

1 Any number of repairs in the crown area only (use outer grooves as a guide). Refer larger injuries to a full service repair shop. Do not overlap patches.

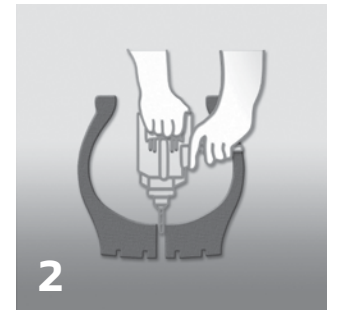

2 Beads in relaxed position. Using a tapered drill bit/carbide cutter, drill a hole from the inside. Using a proper reamer, lubricate the hole with chemical cement.



3 Brush chemical cure cement on nozzle and insert into the hole while turning clockwise.



4 Cut excess plug 1/16" high on inside. Do not stretch plug.

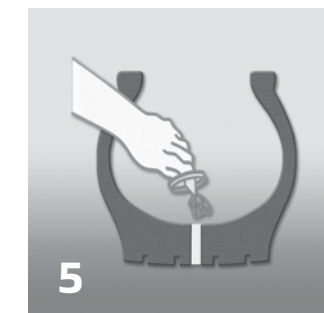

5 Apply brush type Nylonbond cement to the buffed surface only and allow to dry thoroughly when using "versacure" patches with heat applied. When heat is not applied, use chemical vulcanizing solution, applied to the buffed liner surface only.



6 Beads in relaxed position. Remove backing from specified "versacure" patch. Center the patch over the plug and stitch the patch from the center out. Arrows on the patch must point toward the tire bead.

SECTION REPAIR LIMITS IN SIDEWALL & SHOULDER AREA

Most sidewall injuries will be split-type, caused by snags and punctures. Maximum injury sizes for sidewall and shoulder repairs are shown below.

The number of these section repairs should be limited to 2 per tire for line haul service and 3 for city service, no closer than 1/4 of tire circumference apart.

Spot repairs may be made without limit proving that the body plies are not exposed or damaged. Existing repairs must be reworked if loose or questionable.

Limited Warranty

Disregarding any of the safety precautions and instructions contained in this information sheet may result in tire failure or explosion causing serious personal injury or death.

WARRANTY TERMS

This limited warranty applies to the original purchaser of any new truck and bus tire manufactured by HANKOOK Tire Co., Ltd bearing Department of Transportation prescribed tire identification numbers. Eligible tires shall be used on the vehicle on which they were originally installed according to the vehicle manufacturer's or Hankook's recommendation. This warranty applies if all following qualification requirements are met:

1. The tire was purchased after January 1, 2022.
2. The tire is a size, load rating and speed rating equal to or greater than that recommended by the vehicle manufacturer.
3. The tire has not become unserviceable due to a condition listed under WHAT IS NOT COVERED

WHAT IS WARRANTED AND FOR HOW LONG

Should any tire covered by this limited warranty become unusable due to a workmanship or material related condition during its usable tread life (more than 2/32nds remaining tread), Hankook will give a credit on the following conditions:

1. During the first 2/32nds of the original usable tread and within one year: Tire will be replaced with a comparable new Hankook produced tire free of charge. Applicable taxes on the new tire and cost of mounting, balancing and any other charges in connection with the replacement of the tire are required to be paid by the owner.
2. After the first 2/32nds of the original usable tread or after one year from date of purchase, whichever occurs first: The amount of the credit will be determined by multiplying the Dealer's current selling price for the same tire (excluding taxes) by the percentage of tread remaining, based on the original tread depth.
3. Free replacement workmanship warranty is not applicable to snow tires.

WHAT IS NOT COVERED

This limited warranty does not apply to tires which are being serviced under the following conditions:

- Originally purchased outside of the United States or Puerto Rico.
- Willful Abuse / Collision / Wreck / Fire.
- Continued use while flat or severe under/over inflation.
- Road Hazards including without limitation, puncture, cut, impact break, stone drill, bruise, bulge, snag, collision.
- Premature/irregular wear due to vehicle mechanical reason and/or improper maintenance.
- Conditions resulting from without limitation, improper mounting/demounting, under inflation, improper tire size, improper repair, defect in vehicle, abuse.
- Ride disturbance complaints after 2/32nds tread wear or 1 year from date of purchase, whichever occurs first.
- With 2/32nds or less of remaining tread depth.
- With the serial/DOT number cut or buffed.
- Racing and Misapplication.
- Tires 6 years or older from the date of manufacture or 6 years or older from the date of purchase.
- Loss of time or use, inconvenience or any incidental or consequential damage.
- Tires worn beyond original full tread depth will not have FET reimbursed.

- Tires with minor cosmetic weather/ozone cracking.
- Ozone or weather cracking on tires over four (4) years old from the date of manufacture.
- Note: Consequential damage mentioned above may not apply to you based on States limitation.

OWNER'S GENERAL OBLIGATION

In order to be eligible for HANKOOK's limited warranty program, the owner must observe the following:

- Present the tire to an authorized Hankook dealer in the United States of America or Puerto Rico.
- Submit or present a copy of the original purchase receipt.
- Sign a completed Hankook Claim Form filled by any authorized dealer.
- If the tire owner abuses the tires by failing to do the following, but not limited to observe safety warnings, maintain proper inflation pressure, maintain vehicle alignment and tire rotation, expected tire performance or life may not be achieved and your safety cannot be ensured.

RETREAD ALLOWANCE

Tread Depth Remaining (Inches)	Total Allowance Retreaded Tires (Retread Allowance + Casing Allowance)
More than 14/32	\$45.00 + Casing Allowance
8/32 to 14/32	\$30.00 + Casing Allowance
Less than 8/32	Casing Allowance Only

- For 19.5 inches or smaller sizes, only casing allowances warranted.
- Tires used in mining and logging service are not covered under this warranty.

CASING WARRANTY

1. Casing of Hankook steel radial truck & bus tires are warranted when tire becomes unserviceable or unretreadable due to factors within manufacturer's condition, Hankook will provide predetermined casing allowance.
2. Casing warranty is valid through the 2nd retreaded life for six (6) years from the date of manufacture. (AL21, AL11, DL11, DL21 casing warranty is valid through unlimited retreads for seven (7) years from the date of manufacture).
3. e³ WIDE (DL07, TL07, TL21, DL12, DL21) casing warranty valid through the 3rd retread for six (6) years from date of manufacture.
4. Retreading allowance is warranted for some limited products besides casing policy based upon remaining casing allowance.
5. Tires used in mining & logging service are not covered under this warranty.
6. Casing & retreading allowance in the following section.

CASING ALLOWANCE

Category	Size	No of Retread				Remark
		Never	1st	2nd	3rd	
Premium Pattern :	295/75R22.5 285/75R24.5	\$130	\$110	\$90	\$70	Casing value will be same after 3rd times retread
AL21, DL11, DL21.	11R22.5 11R24.5					
e ³ Wide Pattern:	445/50R22.5	\$150	\$120	\$90	\$70	Casing value will be same after 3rd times retread
DL07, TL07, TL21, DL12, DL21,						
Normal	11R22.5 11R24.5 255/70R22.5 275/70R22.5 295/75R22.5 305/70R22.5	\$110	\$90	\$70	-	
	315/80R22.5 285/75R24.5 385/65R22.5 425/65R22.5 445/65R22.5					
Normal	9.00R20 10.00R20 11.00R20 12.00R20	\$90	\$80	\$70	-	
	12.00R20					
Normal	215/75RL7.5 235/75R17.5 8R19.5	\$60	\$40	\$30	-	
	225/70R79.5 245/70R19.5 265/70Rr9.5					

DISCLAIMER

THIS WARRANTY IS MADE IN LIEU OF ALL OTHER WARRANTIES, EXPRESS OR IMPLIED, AND HANKOOK EXPRESSLY DISCLAIMS ALL IMPLIED WARRANTIES OF MERCHANTABILITY OR FITNESS FOR A PARTICULAR PURPOSE. SOME U.S. STATES AND/OR CANADIAN PROVINCES DO NOT ALLOW LIMITATIONS IN THE DURATION OF AN IMPLIED WARRANTY, SO THE ABOVE MAY NOT APPLY TO YOU.

TO THE EXTENT PERMITTED BY LAW, HANKOOK DISCLAIMS LIABILITY FOR ALL CONSEQUENTIAL AND INCIDENTAL DAMAGES.

THE REMEDIES SET FORTH IN THIS LIMITED WARRANTY ARE THE SOLE AND EXCLUSIVE REMEDIES FOR BREACH OF WARRANTY.

Some U.S. States and/or Canadian provinces do not allow the exclusion or limitation of incidental or consequential damages, so the above limitation or exclusion may not apply to you. This Limited Warranty gives you specific legal rights, and you may also have other rights which vary from U.S. State or

Canadian province to province.

• THIS IS THE ONLY EXPRESS WARRANTY MADE BY HANKOOK. NO HANKOOK EMPLOYEE, RETAILER, OR DEALER HAS THE AUTHORITY TO MAKE ANY WARRANTY,

REPRESENTATION, PROMISE OR AGREEMENT ON BEHALF OF HANKOOK EXCEPT AS EXPRESSLY WRITTEN IN THIS TOTAL WARRANTY. IN OBSERVANCE OF U.S. FEDERAL LAW, THIS WARRANTY HAS BEEN DESIGNATED A "LIMITED WARRANTY."

ADDITIONAL INFORMATION OR CUSTOMER SERVICE

If you have any question on product warranty, please first contact your nearest Hankook Tire Dealer. For dealer information, or if your question has not been handled to your satisfaction, contact the Hankook Tire Technical Department.

HANKOOK TIRE AMERICA CORPORATION

1-800-HANKOOK

333 Commerce St. Suite 600 Nashville, TN 37201

For warranty information, please visit

hankooktire.com/us or call 1-800-HANKOOK , option 1 for Technical Dept.

Claim Adjustment Procedure

For all claims for adjustment, a claim form must be filled out. Adjustment claims can be completed online at (eorder.hankooktire.com/) by logging in and accessing the "Warranty Return" section. Completed claim form shall be mailed to Hankook Tire America Corp. office. Do not ship tires to Hankook unless requested to OR you meet the minimum requirements of Hankook's TBR tire shipping policy (page 43). Hankook reserves the right to demand physical inspection of the tires on which adjustment is claimed.

A. If the examination shows that the tire is adjustable under the terms of our Warranty

1. Be sure that the tire returned by the consumer bears our name and DOT number.
2. Measure the remaining tread depth in 32nds of an inch. Be sure to measure in grooves nearest the center line of the tire.
3. Refer to ORIGINAL TREAD DEPTH for the size and type of the returned tire. Use the ORIGINAL TREAD DEPTH CHART to determine the percentage of credit due based on remaining tread depth.
4. Fill out the HANKOOK TIRE CLAIM FORM completely (can be filled online), sign it yourself and have it signed by the owner of the tire.

B. Fill out each claim form with the following information for each tire being adjusted

Adjustment claims can be completed online at (eorder.hankooktire.com/) by logging in and accessing the "Warranty Return" section. For hand written claims, see example shown on page 41. This form must be accurately completed by the dealer and signed by the owner of the product. Incomplete forms will not be accepted.

C. Marking tires for physical inspection

For accumulation of 6 tires or greater, follow Hankook's shipping policy (page 38). Please mark all tires being shipped to our claim center in the following manner.

1. Clearly state dealer's name.
2. Mark over identification (DOT) number with crayon and make clearly legible (Disregard if DOT has been cut & sent in with claim).
3. Tire condition - circle area of failure (a two inch crayon mark around the condition). Ride complaints should be marked as "O.R."
4. Write claim number close to DOT number using the last two digits of claim number and line number from the claim form. Example: If claim number is "H5001234" and the tire is from line "2", then the number you would mark on the tire would be "34-2".
5. Attach a copy of all claim forms and any supporting documents (purchase record, install record, maintenance docs, etc.) to one of the

tires, or give to carrier driver.

D. For photo inspection

Accumulation of 5 tires or less: Complete Hankook Claim Form, with dealer point of contact information, and send relevant invoices/documents and also photographs of the condition(s) being claimed. Upon receipt, Hankook will review and approve or reject the claim. Upon notification of approval, DOT will need to be skived from the tire(s) and mailed with reference to the corresponding claim form number (ex. H1234567) within 28 days from notice of approval.

E. Forwarding claim forms to Hankook

Retain "Dealer's Copy" and retain copies of any other supporting documents and/or photos for dealer records, and forward all other copies to:
Hankook Tire America Corp.
Attn: Technical Department
333 Commerce Street Suite 600
Nashville, TN 37201

When an adjustment is received, Hankook will...

Review the claim and either issue credit or request the tires to be shipped to our claim center for physical inspection. If we decide a physical inspection is necessary, we will send you a written request to ship the tires to a designated location.

NOTE: DO NOT send tires to our claim centers unless you are requested to do so OR you meet the minimum requirements of Hankook's TBR tire shipping policy (page 38).

Tires must be held by you for thirty days or until credit or further notice has been received, whichever is later. If tires are requested to be shipped for inspection during this period and are not available, claim will be disallowed and adjustment credit will not be issued.

If Hankook exercises its right to inspect, it will do so by sending a written request to ship the tires to Hankook's Claim Center. In determining the cause for removal from service, always examine both the inside and outside of the tire body. If the tire is not entitled to adjustment, Hankook will advise the dealer; explain the reason for the failure and advise him/her of preventive maintenance.

Remember :

1. Adjustments will be made on a pro-rata basis, calculated on remaining usable tread depth and the Dealer's current selling price of the same tire, if there is no applicable special warranty program.
2. Usable tread depth is the original depth less 2/32nds of an inch.
3. When the tire is worn down to 2/32nds or less, the tire is considered worn out and the limited warranty expires.
4. For photo inspection on tires still usable/retreadable, do not skive and mail DOT until adjustment is approved by Hankook Technical Department.
5. The result of physical inspections by Hankook will prevail over your findings to the contrary subject to your right to legally contest our findings.
6. Where physical inspection is required, please refer to page 39, section "E. Marking tires for physical inspection" and page 43 "Freight Policy" for tire marking and shipping instruction.

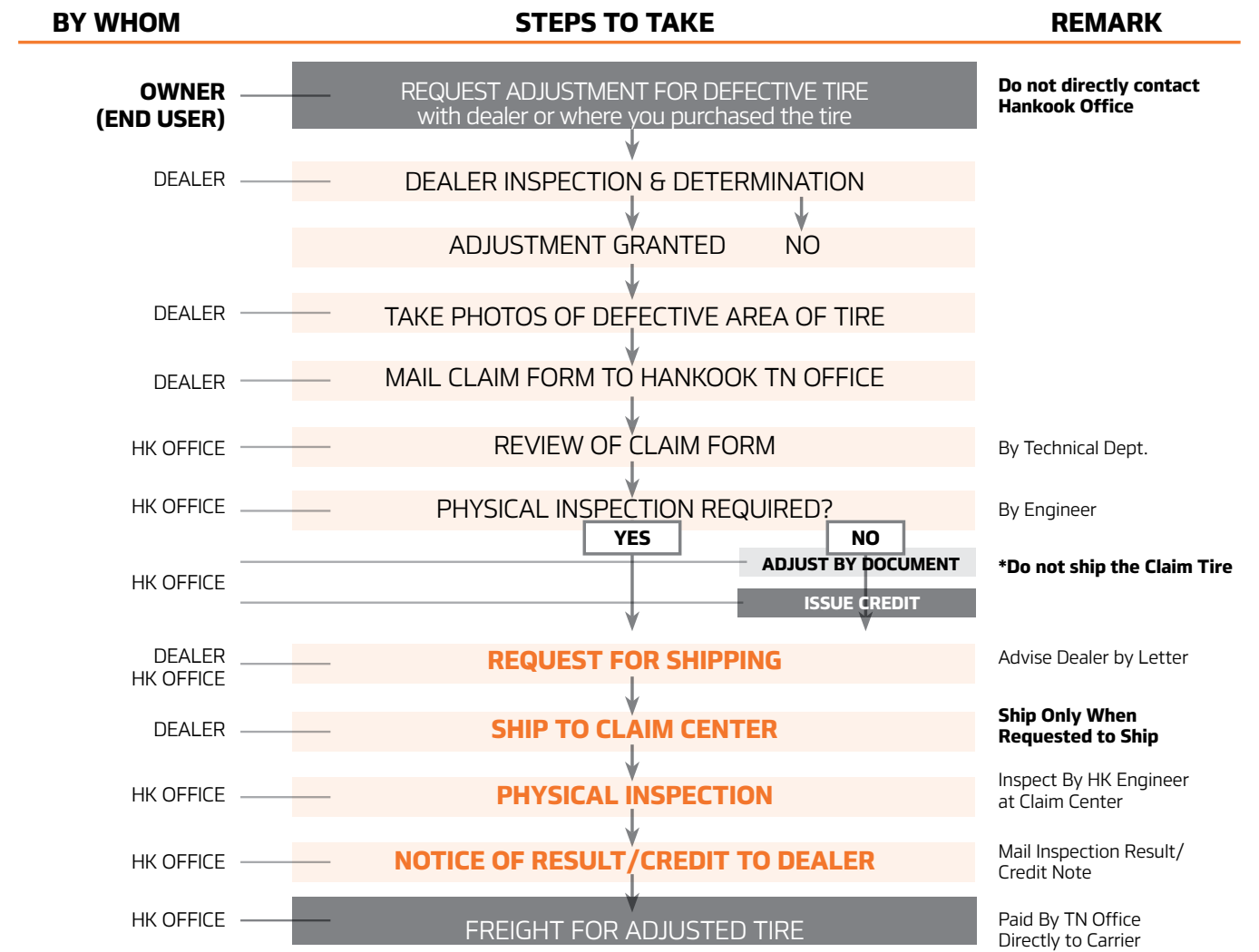

NOTE : No freight will be paid where shipment of tire was not required. Where tires are shipped to wrong address or shipped where not requested, freight will be paid by shipper.

Paper Form

HANKOOK TIRE WARRANTY CLAIM FORM H
driving emotion

HANKOOK TIRE AMERICA CORP. Technical Department
333 Commerce Street, Suite 600
Nashville, TN 37201
Tel: 1-800-HANKOOK (426-5665), opt 1

THIS FORM MUST BE ACCURATELY COMPLETED BY THE DEALER AND SIGNED BY OWNER USING THE PRODUCT. INCOMPLETE FORMS WILL NOT BE ACCEPTED.

1 DATE OF CLAIM

2 DISTRIBUTOR **3** DEALER **4** FLEET (Commercial Use Only) **5** OWNER-USER

6 NAME: **7** YEAR: **8** MAKE: **9** MODEL: **10** VIN NUMBER: **11** VEHICLE USAGE (NORMAL / COMMERCIAL / OFFROAD / RACING / ETC.) **12** ORIGINAL EQUIPMENT: Yes No **13** IF "YES", DATE VEHICLE PURCHASED:

14 INSTALL DATE: **15** INSTALL MILES: **16** REMOVAL DATE: **17** REMOVAL MILES: **18** TOTAL MILE: **19** STAGGERED FITMENT: Yes No

ITEM NO.	SIZE / PLY	PATTERN	PART / MATERIAL NO.	HTAC USE ONLY	D.O.T. NUMBER	BARCODE (LOCATED ON BEAD)	REM. TREAD DEPTH	HTAC RSD	TIRE MILES	TIRE POSITION (LF, RF, LR, RR)	CLAIM REASON	# OF RETREADS
1.	20	21	22		23	24	25 /32		26	27	28	29
2.							/32					
3.							/32					
4.							/32					
5.							/32					
6.							/32					

30 NOTICE TO OWNERS FREIGHTING TIRES: If claim is disallowed, the product will be scrapped unless the box below is checked:
 RETURN FREIGHT COLLECT ("POINT OF CONTACT FOR CLAIM SUBMISSION" field must be completed)

31 If claiming for 30 Day Trial, please indicate return reason(s):
Please check all that apply:
 Vibration Wet Traction Tracking/Pulling/Wandering
 Handling Snow Traction Braking
 Noise Dry Traction Other: _____
 Efficiency Appearance _____

32 Dealer's Signature **33** Owner-User's Signature

HTAC USE ONLY
Date Received: Initials:
V: V: W: W: O: O:

TIRES MUST BE HELD UNTIL FURTHER NOTICE, OR UNTIL CREDIT IS RECEIVED. SHOULD TIRES BE REQUESTED FOR INSPECTION AND BE UNAVAILABLE, ADJUSTMENTS CREDIT WILL NOT BE ISSUED.

PLEASE SEE REVERSE SIDE FOR COMPLETE INSTRUCTIONS FOR SUBMITTING CLAIM.

NOTE : Please completely fill in the following items:

- | | | |
|--|------------------------|----------------------------|
| 1. Date of Claim | 12. Original Equipment | 24. Barcode |
| 2. Distributor/Wholesaler Info | 13. Date Purchased | 25. Remaining Tread Depth |
| 3. Dealer/Retailer Info | 14. Install Date | 26. Tire Miles |
| 4. Fleet Info | 15. Install Miles | 27. Tire Position |
| 5. Owner-User Info (End User) | 16. Removal Date | 28. Claim Reason |
| 6. Contact Info for Person Preparing Claim | 17. Removal Miles | 29. Number of Treads |
| 7. Vehicle Year | 18. Total Miles | 30. Return Freight Collect |
| 8. Vehicle Make | 19. Staggered Fitment | 31. Claiming 30 Day Trial |
| 9. Vehicle Model | 20. Size/Ply | 32. Dealer's Signature |
| 10. Vehicle VIN Number | 21. Pattern | 33. Owner-User's Signature |
| 11. Vehicle Usage | 22. Part/Material No. | |
| | 23. D.O.T. Number | |

Weborder Form

HANKOOK Web Order system

WELCOME DEALER | PRODUCT | HELP DESK | CART | DASHBOARD | LOGOUT

ORDER NATIONAL ACCOUNT STATUS REPORT WARRANTY RETURN

Warranty Return

Create Warranty Return Warranty Return Status

Distributor

Name: Address: Phone Number: Acct: Email:

Ship-To

Ship-to: Address: Phone Number: Acct: Email:

Point Of Contact

Name *: Phone Number *: Email:

Vehicle Information

Year: Maker: Model: Install Date: MM DD YYYY Install Miles: Removal Miles: Total Miles: Vehicle usage: Original equipment: VIN number:

Tire Information

Material No.	Size	Type	Ply	TBR Serial No.	D.O.T. Number	Barcode	PSI	32nds Remaining

For all claims for warranty adjustment, a warranty claim form must be filled out. Warranty claims can be completed online at **(eorder.hankooktire.com)** by logging in and accessing the "Warranty Return" section. Warranty claims can also be completed on paper Tire Warranty Claim Forms. Completed paper claim forms must be mailed to Hankook Tire America Corp. office. Do not ship tires to Hankook unless requested to OR you meet the minimum requirements of Hankook's TBR tire shipping policy (page 47). Hankook reserves the right to demand physical inspection of the tires on which adjustment is claimed.

Credit Percentage Table 1

Remaining Tread Depth	ORIGINAL TREAD DEPTH (1/32")																					
	(1/32)	8.5	9.0	9.5	10.0	10.5	11.0	11.5	12.0	12.5	13.0	13.5	14.0	14.5	15.0	15.5	16.0	16.5	17.0	17.5	18.0	18.5
2.0	0	0	0	0	0	0	0	0	0	0	0	0	0	0	0	0	0	0	0	0	0	0
2.5	8	7	7	6	6	6	5	5	5	5	4	4	4	4	4	4	3	3	3	3	3	3
3.0	15	14	13	13	12	11	11	10	10	9	9	8	8	8	7	7	7	7	6	6	6	6
3.5	23	21	20	19	18	17	16	15	14	14	13	13	12	12	11	11	10	10	10	9	9	9
4.0	31	29	27	25	24	22	21	20	19	18	17	17	16	15	15	14	14	13	13	13	12	12
4.5	39	36	33	31	29	28	26	25	24	23	22	21	20	19	19	18	17	17	16	16	15	15
5.0	46	43	40	38	35	33	32	30	29	27	26	25	24	23	22	21	21	20	19	19	18	18
5.5	54	50	47	44	41	39	37	35	33	32	30	29	28	27	26	25	24	23	23	22	21	21
6.0	62	57	53	50	47	44	42	40	38	36	35	33	32	31	30	29	28	27	26	25	24	24
6.5	69	64	60	56	53	50	47	45	43	41	39	38	36	35	33	32	31	30	29	28	27	27
7.0	77	71	67	63	59	56	53	50	48	45	43	42	40	38	37	36	34	33	32	31	30	30
7.5	85	79	73	69	65	61	58	55	52	50	48	46	44	42	41	39	38	37	35	34	33	33
8.0	92	86	80	75	71	67	63	60	57	55	52	50	48	46	44	43	41	40	39	38	36	36
8.5	100	93	87	81	76	72	68	65	62	59	57	54	52	50	48	46	45	43	42	41	39	39
9.0		100	93	88	82	78	74	70	67	64	61	58	56	54	52	50	48	47	45	44	42	42
9.5			100	94	88	83	79	75	71	68	65	63	60	58	56	54	52	50	48	47	45	45
10.0				100	94	89	84	80	76	73	70	67	64	62	59	57	55	53	52	50	48	48
10.5					100	94	89	85	81	77	74	71	68	65	63	61	59	57	55	53	52	52
11.0						100	95	90	86	82	78	75	72	69	67	64	62	60	58	56	55	55
11.5							100	95	90	86	83	79	76	73	70	68	66	63	61	59	58	58
12.0								100	95	91	87	83	80	77	74	71	69	67	65	63	61	61
12.5									100	95	91	88	84	81	78	75	72	70	68	66	64	64
13.0										100	96	92	88	85	81	79	76	73	71	69	67	67
13.5											100	96	92	88	85	82	79	77	74	72	70	70
14.0												100	96	92	89	86	83	80	77	75	73	73
14.5													100	96	93	89	86	83	81	78	76	76
15.0														100	96	93	90	87	84	81	79	79
15.5															100	96	93	90	87	84	82	82
16.0																100	97	93	90	88	85	85
16.5																	100	97	94	91	88	88
17.0																		100	97	94	91	91
17.5																			100	97	94	94
18.0																				100	97	97
18.5																					100	100

Credit Percentage Table 2

Remaining Tread Depth	ORIGINAL TREAD DEPTH (1/32")																					
	(1/32)	13	14	15	16	17	18	19	20	21	22	23	24	25	26	27	28	29	30	31	32	
2	0	0	0	0	0	0	0	0	0	0	0	0	0	0	0	0	0	0	0	0	0	
3	9	8	8	7	7	6	6	6	5	5	5	5	4	4	4	4	4	4	4	3	3	
4	18	17	15	14	13	13	12	11	11	10	10	9	9	8	8	8	7	7	7	7	7	
5	27	25	23	21	20	19	18	17	16	15	14	14	13	13	12	12	11	11	10	10	10	
6	36	33	31	29	27	25	24	22	21	20	19	18	17	17	16	15	15	14	14	13	13	
7	45	42	38	36	33	31	29	28	26	25	24	23	22	21	20	19	19	18	17	17	17	
8	55	50	46	43	40	38	35	33	32	30	29	27	26	25	24	23	22	21	21	20	20	
9	64	58	54	50	47	44	41	39	37	35	33	32	30	29	28	27	26	25	24	23	23	
10	73	67	62	57	53	50	47	44	42	40	38	36	35	33	32	31	30	29	28	27	27	
11	82	75	69	64	60	56	53	50	47	45	43	41	39	38	36	35	33	32	31	30	30	
12	91	83	77	71	67	63	59	56	53	50	48	45	43	42	40	38	37	36	34	33	33	
13	100	92	85	79	73	69	65	61	58	55	52	50	48	46	44	42	41	39	38	37	37	
14		100	92	86	80	75	71	67	63	60	57	55	52	50	48	46	44	43	41	40	40	
15			100	93	87	81	76	72	68	65	62	59	57	54	52	50	48	46	45	43	43	
16				100	93	88	82	78	74	70	67	64	61	58	56	54	52	50	48	47	47	
17					100	94	88	83	79	75	71	68	65	63	60	58	56	54	52	50	50	
18						100	94	89	84	80	76	73	70	67	64	62	59	57	55	53	53	
19							100	94	89	85	81	77	74	71	68	65	63	61	59	57	57	
20								100	95	90	86	82	78	75	72	69	67	64	62	60	60	
21									100	95	90	86	83	79	76	73	70	68	66	63	63	
22										100	95	91	87	83	80	77	74	71	69	67	67	
23											100	95	91	88	84	81	78	75	72	70	70	
24												100	96	92	88	85	81	79	76	73	73	
25													100	96	92	88	85	82	79	77	77	
26														100	96	92	89	86	83	80	80	
27															100	96	93	89	86	83	83	
28																100	96	93	90	87	87	
29																	100	96	93	90	90	
30																		100	97	93	93	
31																			100	97	97	
32																					100	100

Load Inflation Pressure Tables

Wide Base, Tubeless											
Tire Size Tire Designation		The Load Limits (lbs.) at Various Cold Inflation Pressures (psi) (The pressure is minimum for the load)									
Tire size Tire Designation		The Load Limits (lbs.) at Various Cold Inflation Pressures (psi) (The pressure is minimum for the load)									
		80	85	90	95	100	105	110	115	120	130
385/65R22.5	S	6940	7350	7650	8050	8230	8510	8820	9050	9370(J)	
425/65R22.5	S	8270	8740	9100	9370	9790	10100	10500(J)	10700	11400(L)	
445/65R22.5	S	9090	9480	9870	10200(H)	10600	11000	11400	11700	12300(L)	12800
445/50R22.5	S	7310	7680	8030	8390	8740	9090	9370(J)	9780	10200(L)	

Tube Type												
Tire Size Tire Designation		The Load Limits (lbs.) at Various Cold Inflation Pressures (psi) (The pressure is minimum for the load)										
Tire size Tire Designation		The Load Limits (lbs.) at Various Cold Inflation Pressures (psi) (The pressure is minimum for the load)										
		80	85	90	95	100	105	110	115	120	125	130
9.00R20	A	16920	17640(E)	18340	19040	19760(F)	20320	20880	21420(G)	22060	22700(H)	
	D	8460	8820(E)	9170	9520	9880(F)	10160	10440	10710(G)	11030	11350(H)	
	S	4480	4675(E)	4850	5025	5205(F)	5360	5515	5675(G)	5840	6005(H)	
10.00R20	A	19040	19800	20820(F)	21660	22500	23360(G)	23580	23800	24020(H)		
	D	9520	9900	10410(F)	10830	11250	11680(G)	11790	11900	12010(H)		
	S	4990	5220	5510(F)	5730	5950	6175(G)	6320	6465	6610(H)		
11.00R20	A	20760	21560	22700(F)	23140	23580	24020(G)	25060	26100	27120(H)		
	D	10380	10780	11350(F)	11570	11790	12010(G)	12530	13050	13560(H)		
	S	5450	5690	6005(F)	6205	6405	6610(G)	6870	7130	7390(H)		
12.00R20	A	23640	24560	25440	26440(G)	27160	27880	28640(H)	29560	30440(J)		
	D	11820	12280	12720	13220(G)	13580	13940	14320(H)	14780	15220(J)		
	S	6200	6480	6740	7160(G)	7380	7600	7830(H)	8050	8270(J)		
12.00R24	A	26600	27640	28640	29560(G)	30440	31320	32200(H)	33200	34160(J)		
	D	13300	13820	14320	14780(G)	15220	15660	16100(H)	16600	17080(J)		
	S	6980	7280	7580	8050(G)	8310	8570	8820(H)	9100	9370(J)		

*OPERATING SPEED LESS THAN 55 MPH

Tire load limits at various inflation pressures are based upon Tire and Rim Association (TRA) standards and tables, except where there is no specification established by the TRA. In these few cases, the tire design is based upon the European Tire and Rim Technical Organization (ETRTO) whose standards govern these tire designs. To obtain recommendations for tires run in non-standard applications, customers and dealers should contact the Hankook Technical Service Department.

A = Load Limit across an Axle (4 Tires) D = Load Limit across Dual tires (2 Tires) S = Load Limit for a single tire

Tubeless												
Tire Size Tire Designation		The Load Limits (lbs.) at Various Cold Inflation Pressures (psi) (The pressure is minimum for the load)										
Tire size Tire Designation		80	85	90	95	100	105	110	115	120	125	130
8R19.5	A	10720(D)	11140	11560	12000(E)	12400	12800	13220(F)				
	D	5360(D)	5570	5780	6000(E)	6200	6400	6610(F)				
	S	2835(D)	2955	3075	3195(E)	3305	3415	3525(F)				
215/75R17.5 (14PR)	A	11620	12200	12760	13320	13880						
	D	5810	6100	6380	6660	6940						
	S	3085	3240	3390	3540	3690						
215/75R17.5 (16PR)	A	12700	13320	13960	14580	15180	15780	16380	16980	17560	18160	
	D	6350	6660	6980	7290	7590	7890	8190	8490	8780	9080	
	S	3360	3525	3690	3855	4015	4175	4335	4490	4650	4805	
235/75R17.5 (14PR)	A	12980	13620	14260	14900	15520	16140	16760				
	D	6490	6810	7130	7450	7760	8070	8380				
	S	3415	3585	3755	3920	4085	4245	4410				
235/75R17.5 (16PR)	A	15680	16460	17220	17980	18740	19480	20220	20960	21680	22400	
	D	7840	8230	8610	8990	9370	9740	10110	10480	10840	11200	
	S	4145	4355	4555	4760	4955	5155	5350	5545	5735	5925	
245/70R17.5 (18PR)	A	15680	16460	17220	17980	18740	19480	20220	20960	21680	22400	
	D	7840	8230	8610	8990	9370	9740	10110	10480	10840	11200	
	S	4145	4355	4555	4760	4955	5155	5350	5545	5735	5925	
10R22.5	A	16920	17640(E)	18340	19040	19760(F)	20300	20840	21420(G)			
	D	8460	8820(E)	9170	9520	9880(F)	10150	10420	10710(G)			
	S	4480	4675(E)	4850	5025	5205(F)	5360	5515	5675(G)			
11R22.5	A	19040	19800	20820(F)	21660	22500	23360(G)	23580	23800	24020(H)		
	D	9520	9900	10410(F)	10830	11250	11680(G)	11790	11900	12010(H)		
	S	4990	5220	5510(F)	5730	5950	6175(G)	6320	6465	6610(H)		
11R24.5	A	20280	21040	22040(F)	22700	23360	24020(G)	24820	25620	26440(H)		
	D	10140	10520	11020(F)	11350	11680	12010(G)	12410	12810	13220(H)		
	S	5310	5550	5840(F)	6095	6350	6610(G)	6790	6970	7160(H)		
12R22.5	A	20760	21560	22700(F)	23140	23580	24020(G)	25060	26100	27120(H)		
	D	10380	10780	11350(F)	11570	11790	12010(G)	12530	13050	13560(H)		
	S	5450	5690	6005(F)	6205	6405	6610(G)	6870	7130	7390(H)		
225/70R19.5	A	12000(E)	12460	12980	13660(F)	13960	14460	15000(G)	15420	15880(H)		
	D	6000(E)	6230	6490	6830(F)	6980	7230	7500(G)	7710	7940(H)		
	S	3195(E)	3315	3450	3640(F)	3715	3845	3970(G)	4100	4190(H)		
245/70R19.5	A	13660	14060	14620	15440(F)	15760	16300	17200(G)	17380	18160(H)		
	D	6830	7030	7310	7720(F)	7880	8150	8600(G)	8690	9080(H)		
	S	3640	3740	3890	4080(F)	4190	4335	4540(G)	4620	4805(H)		
265/70R19.5	A	15000	15720	16380	17200	17620	17660	18700(G)				
	D	7500	7860	8190	8600	8810	8830	9350(G)				
	S	3970	4180	4355	4540	4685	4850	5070(G)				
245/75R22.5	A	14100	14460	15060	15880	16220	16780	17200(G)				
	D	7050	7230	7530	7940	8110	8390	8600(G)				
	S	3860	3975	4140	4300	4455	4610	4675(G)				
255/70R22.5	A	15880	16440	17100	17640	17820	18440	18700(G)	19660	20280(H)		
	D	7940	8220	8550	8820	8910	9220	9350(G)	9830	10140(H)		
	S	4190	4370	4550	4675	4895	5065	5205(G)	5400	5510(H)		
275/80R22.5 (16PR)	A	18500	19420	20320	21220	22100	22980	23860	24720	25580	26440	
	D	9250	9710	10160	10610	11050	11490	11930	12360	12790	13220	
	S	5010	5260	5505	5750	5990	6230	6465	6700	6930	7165	
275/70R22.5 (18PR)	A	17240	18080	18940	19780	20600	21420	22240	23040	23840	24620	25420
	D	8620	9040	9470	9890	10300	10710	11120	11520	11920	12310	12710
	S	4675	4905	5135	5365	5590	5810	6030	6250	6465	6680	6895
295/75R22.5	A	18160	18760	19540	20280(F)	21040	21760	22700(G)	23180	24020(H)		
	D	9080	9380	9770	10140(F)	10520	10880	11350(G)	11590	12010(H)		
	S	4940	5155	5370	5510(F)	5780	5980	6175(G)	6370	6610(H)		
315/80R22.5 (20PR)	A	22700	23360	24280	25580	26180	27080	27760	28840	30440	31640	33080
	D	11350	11680	12140	12790	13090	13540	13880	14420	15220	15820	16540
	S	6175	6415	6670	6940	7190	7440	7610	7920	8270	8690	9090
315/80R22.5 (20PR) (AM06, AM09+)	A	24640	25880	27080	28280	29460	30640	31800	32960	34100	35220	36360
	D	12320	12940	13540	14140	14730	15320	15900	16480	17050	17610	18180
	S	6780	7115	7450	7780	8105	8425	8745	9065	9375	9690	10000
305/70R22.5 (20PR)	A		21070	21930	23060	23870	24710	25790	26600	27680	28480	29560
	D		10535	10965	11530	11935	12355	12895	13300	13840	14240	14780
	S		5740	5970	6280	6500	6735	7030	7250	7535	7760	8050
285/75R24.5	A	18160	18960	19720	20820(F)	21240	21980	22700(G)	23440	24700(H)		
	D	9080	9480	9860	10410(F)	10620	10990	11350(G)	11720	12350(H)		
	S	4940	5210	5450	5675(F)	5835	6040	6175(G)	6440	6780(H)		